

HEWLETT-PACKARD

NEW

A

P

M

©

C

410B

VACUUM TUBE VOLTMETER

SERIALS PREFIXED: 024-

OPERATING AND SERVICING MANUAL



OPERATING AND SERVICING MANUAL



MODEL 410B VACUUM TUBE VOLTMETER SERIALS PREFIXED: 024 -



SPECIFICATIONS

RANGES: 1 to 300 volts full scale in 6 ranges: 1, 3, 10, 30, 100, and 300 volts AC or DC and 0-1000 volt range DC. Resistance 0.2 ohm to 500 megohms in seven ranges. Mid-scale reading of 10, 100, 1,000, 10,000, 100,000 ohms, 1 megohm, and 10 megohms.

ACCURACY: $\pm 3\%$ of full scale on all ranges on sinusoidal AC voltages and DC voltages. The AC portion of the instrument is a peak-reading device, calibrated in rms volts. Ohmmeter accuracy is ± 1 ohm at mid-scale of RX1 range, $\pm 5\%$ at mid-scale of all other ranges.

FREQUENCY RESPONSE: Frequency response is flat within ± 1 db up to 700 mc and drops off less than 1 db at 20 cps. Probe resonant frequency is about 1,250 mc and an indication can be obtained up to 3,000 mc.

INPUT IMPEDANCE: Input capacity is 1.5 $\mu\mu$ f; input resistance is 10 megohms at low frequencies. At high frequencies resistance drops off due to dielectric losses. DC input resistance is approximately 122 megohms for all ranges.



PROBE: The probe is approximately 1" diameter and 4-1/2" long. It is equipped with a ground clip, and the connector may be soldered to the point under test. Adapting connectors are available to measure voltages in coaxial transmission lines.

POWER SUPPLY: 115/230 volts $\pm 10\%$, 50/1,000 cps, 40 watts.

SIZE: Cabinet Mount: 11-1/2" high, 7-3/8" wide, 8-3/4" deep. Compartment at rear of instrument stores probe and test leads when not in use.

WEIGHT: Cabinet Mount: 12 lbs. ; shipping weight approximately 17 lbs.
Rack Mount: 12 lbs. ; shipping weight approximately 26 lbs.

RACK MOUNTING: Available on standard RETMA 7" x 19" panel.

ACCESSORIES AVAILABLE:  452A Capacitive Voltage Divider, 25 KV max., requires  452A-95A Adapter.

 453A Capacitive Voltage Divider, 2 KV max.

 455A Probe Coaxial "T" Connector, for Type "N" systems.

 458A Probe Coaxial "N" Connector, terminates Type "N" systems.

 459A DC Resistive Voltage Multiplier, 30 KV max.

CONTENTS

SECTION I

GENERAL

1 - 1	General Description	I - 1
1 - 2	Power Line Voltage	I - 1
1 - 3	Three Conductor Power Cable	I - 1
1 - 4	Accessories	I - 2
1 - 5	Initial Assembly of the Probe Assembly	I - 2
1 - 6	Meter Movement Mechanical Zero	I - 2

SECTION II

OPERATING INSTRUCTIONS

2 - 1	Operating Controls and Terminals	II - 1
2 - 2	Operating Adjustments	II - 1
2 - 3	Step-by-Step Operating Procedures	II - 2
2 - 4	Procedure for Measuring DC Voltages	II - 2
2 - 5	Procedures for Measuring AC Voltages	II - 3
2 - 6	Procedure for Measuring Resistances	II - 4
2 - 7	Electrical Characteristics of the Diode and Probe	II - 4
2 - 8	AC Measurement Precautions	II - 6
2 - 9	Pulse Measurements	II - 7
2 - 10	Resistance Measurement Above 500 Megohms	II - 8

SECTION III

THEORY OF OPERATION

3 - 1	General	III - 1
3 - 2	R-F Rectifier	III - 2
3 - 3	Range Extending Resistors	III - 3
3 - 4	DC Amplifier	III - 3
3 - 5	Meter Circuit	III - 3
3 - 6	Resistance Measurement	III - 5
3 - 7	Power Supply	III - 5

SECTION IV

MAINTENANCE

4 - 1	Introductory	IV - 1
4 - 2	Tube Replacement	IV - 1
4 - 3	Replacement of Ballast Tube V6	IV - 3
4 - 4	Basic Voltage Calibration	IV - 3
4 - 5	AC Voltage Calibration	IV - 4
4 - 6	Ohmmeter Adjustments	IV - 4
4 - 7	Trouble Shooting Chart	IV - 5

SECTION V

TABLE OF REPLACEABLE PARTS

5 - 1	Table of Replaceable Parts	V - 1
-------	--------------------------------------	-------

CAUTION

The a-c probe shell, the common ground clip lead, the instrument chassis and cabinet, and the green grounding lead in the three-conductor power cable are electrically connected together at all times. When the NEMA connector is used in the proper manner, a ground path is established between the 410B and equipment which is also grounded. Do not connect the ground clip lead or the a-c probe body to any point which is not at ground potential because a short circuit will be created. If such a measurement is necessary, disconnect the NEMA ground in the power cable by using an adapter with the grounding pig-tail removed, and the cabinet insulated from ground. The 410B cabinet will be at the same potential as the negative clip lead. Caution must be used if the clip lead is connected to a point which is more than a few volts off ground. Because of the potential hazard to personnel, this method is not recommended.

One side of almost all power distribution systems is grounded. Extreme caution must be used if direct measurement of power system voltages is attempted. If the ground clip lead is accidentally connected to the ungrounded side of the line, severe damage to the 410B is possible because of the short circuit created. Power line voltages can be safely measured by using the probe Tip only. Contacting the grounded power conductor will give a reading of 0 volts while contacting the ungrounded lead will give full line voltage reading.

The 410B is designed for the measurement of audio and r-f voltages and is excellent for this purpose. In normal practice these voltages are almost always measured with respect to chassis ground and no concern need be given to grounds. D-C voltages can almost always be determined by measurements with respect to ground, either directly or by subtraction.

SECTION I GENERAL

1-1 GENERAL DESCRIPTION

The Φ Model 410B is a laboratory quality volt-ohmmeter that has been especially designed for making accurate voltage measurements in the frequency range from 20 cps to over 700 mc per second, with useful indications at frequencies as high as 1500 megacycles. The instrument has full scale a-c ranges of 1, 3, 10, 30, 100 and 300 volts, with an input resistance of 10 megohms at low frequencies, shunted by 1.5 μmf . Dc ranges are provided with full scale values of 1, 3, 10, 30, 100, 300 and 1,000 volts. The dc input resistance is approximately 122 megohms on all ranges. The ohmmeter ranges have mid-scale values of 10, 100, 1,000, 10,000, 100,000, 1,000,000, and 10,000,000 ohms. Accurate resistance readings from 1 ohm to 500 megohms are easily made.

The meter scale calibration is very straight forward. All dc voltage ranges and ac ranges 10 volts and above are read on two black scales calibrated 0-1 and 0-3. Due to non linearity of the diode at very low voltages, the 1 and 3 volt ac ranges are read on special, separate, red scales.

All resistance readings are made on one OHMS scale. Figure 1-1 is a drawing of the 410B meter scales.

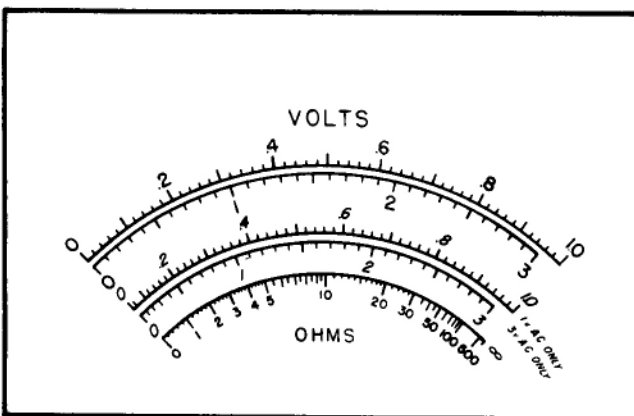

Figure 1-1. Meter Scale Calibration Φ 410B

Power for the ohmmeter circuits is supplied by the instrument power supply which eliminates the necessity of using any battery with its attendant maintenance.

The high accuracy obtained with all voltage measurements makes the Φ Model 410B useful for a wide variety of laboratory and field applications, especially in high frequency work. Construction of the a-c probe is such as to enable the operator to minimize lead length and input capacity, factors which usually restrict the high frequency range in instruments of this type. The wide range of a-c and d-c voltage and resistance measurements combined with convenience of operation make the 410B very useful for all types of circuit testing and trouble shooting as well as development work.

1-2 POWER LINE VOLTAGE

When the instrument leaves the factory, the dual 115 volt primary windings of the power transformer are connected in parallel for operation from a nominal 115 volt source. If operation from a nominal 230 volt supply is desired, the windings may be easily reconnected in series. Refer to the schematic drawing for details. Install the correct power line fuse as listed in the Table of Replaceable Parts.

1-3 THREE CONDUCTOR POWER CABLE

The three conductor power cable supplied with this instrument is terminated in a polarized three-prong male connector recommended by the National Electrical Manufacturers' Association. The third contact is an offset round pin, WHICH GROUNDS THE INSTRUMENT CHASSIS when used with the appropriate receptacle. To use the NEMA connector

in a standard two-contact receptacle, a three-prong to two-prong adapter should be used. The ground connection emerges from the adapter as a short lead which should be connected to a suitable ground for the protection of operating personnel.

1-4 ACCESSORIES

The 410B is not furnished with any accessories, however a number of special accessories are made by $\text{\textcircled{P}}$ which extend the a-c and d-c voltage range of the instrument and facilitate a-c measurements in coaxial systems. A description of these accessories and their specifications is contained below; the accessories are shown in Figure 1-2.

a. $\text{\textcircled{P}}$ Model 453A Capacitive Voltage Divider -

The Model 453A Capacitive Divider shown in Figure 1-2a extends the a-c voltage range of the 410B Multimeter to 2000 volts rms. The divider is for use at frequencies above 10 kilocycles. Voltage division is 100:1, $\pm 1\%$, and the input capacity is approximately 2 micromicrofarads.

b. $\text{\textcircled{P}}$ Model 452A Capacitive Voltage Divider -

The Model 452A Capacitive Divider shown in Figure 1-2b extends the a-c voltage range of the 410B Multimeter to as much as 25 kilovolts. This divider permits measurement of extremely high a-c voltages such as are encountered in dielectric heating equipment and similar applications. The frequency range of the divider is from 25 cps to 20 mc, although as frequency increases, the divider is de-rated to limit the r-f current flowing through its capacitors. A fixed gap is provided so that breakdown will occur if the applied voltage exceeds about 28 kv at low frequencies. Voltage division is 1000:1, $\pm 3\%$, and the input capacity is 15 micromicrofarads. An adapter, $\text{\textcircled{P}}$ 452A-95A, is also required to connect the 410B AC probe to the shielded banana plug fitting of the 452A. (The 452A fitting is designed for use with a $\text{\textcircled{P}}$ 400D type meter.)

c. $\text{\textcircled{P}}$ Model 458A Probe Coaxial "N" Connector -

The Model 458A coaxial connector shown in Figure 1-2c allows the a-c probe of the 410B Multimeter to be connected to a 50-ohm coaxial line. The connector uses a female type N connector and a receptacle for receiving the a-c probe of the 410B voltmeter. No terminating resistor is included.

d. $\text{\textcircled{P}}$ Model 455A Coaxial "T" Connector -

For measurements at the higher frequencies the special T-joint shown in Figure 1-2d has been

designed for connecting the 410B Multimeter across a 50-ohm transmission line using type N connectors. The T-joint has been designed so that the connection of the multimeter into a transmission line circuit will not cause a standing wave ratio greater than 1.1 at 500 megacycles and 1.2 at 1000 megacycles. With the aid of this device, measurement of power traveling through a transmission line may be made with reasonable accuracy to 1000 mc. The usual precautions must be taken to provide accurate impedance matching and the elimination of standing waves along the line through which power is flowing. By using a dummy load at the receiving end of this T-joint, power output of various devices can be measured. In many applications power going into a real load, such as an antenna, can be conveniently measured up to frequencies as high as 1000 megacycles with good accuracy.

e. $\text{\textcircled{P}}$ Model 459A DC Resistive Voltage Multiplier

The Model 459A dc voltage divider shown in Figure 1-2e extends the dc voltage range of the $\text{\textcircled{P}}$ Model 410B to a maximum of 30 kilovolts. Division ratio is 100:1, $\pm 5\%$, and the input impedance is 12,000 megohms. This probe offers maximum safety and convenience for measuring high voltages such as in television equipment, etc. The maximum circuit loading is 2.5 microamperes.

1-5 INITIAL ASSEMBLY OF THE PROBE ASSEMBLY

The 410B is shipped from the factory with the probe assembly packed in a compartment accessible by removal of the rear cover. The banana-plug connector should be plugged into the bottom of the instrument and secured with the two machine screws.

1-6 METER MOVEMENT MECHANICAL ZERO

Whenever the meter pointer does not indicate exactly on zero, the pointer should be reset to zero. For most accurate positioning of the pointer, turn the instrument on for about 15 minutes to allow it to reach operating temperature. Turn off the power and wait at least 30 seconds for the capacitors in the instrument to discharge.

The adjust screw is in the meter frame at a mid-point immediately below the meter face. The adjustment is made properly only when the pointer is traveling in the opposite direction to the turn of the adjust screw. Although the adjust screw may be turned in either direction, a practical procedure is to turn the screw in a clockwise direction until the pointer starts to swing back toward zero. Then, still turning the screw clockwise, bring the pointer (now traveling counterclockwise), back to zero.

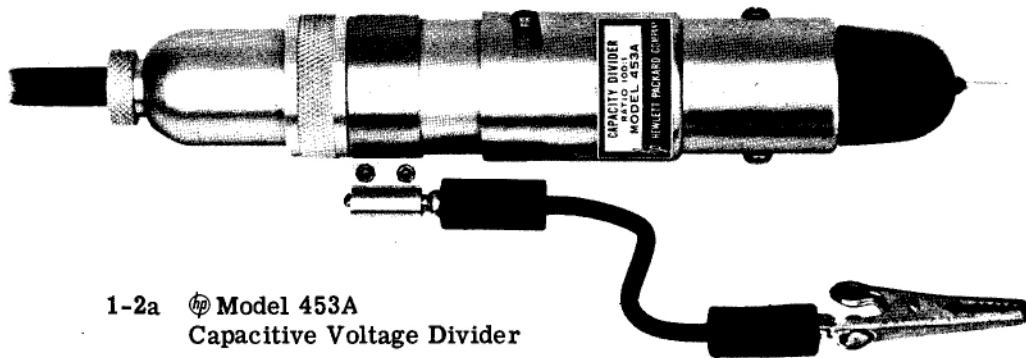



1-2a  Model 453A
Capacitive Voltage Divider

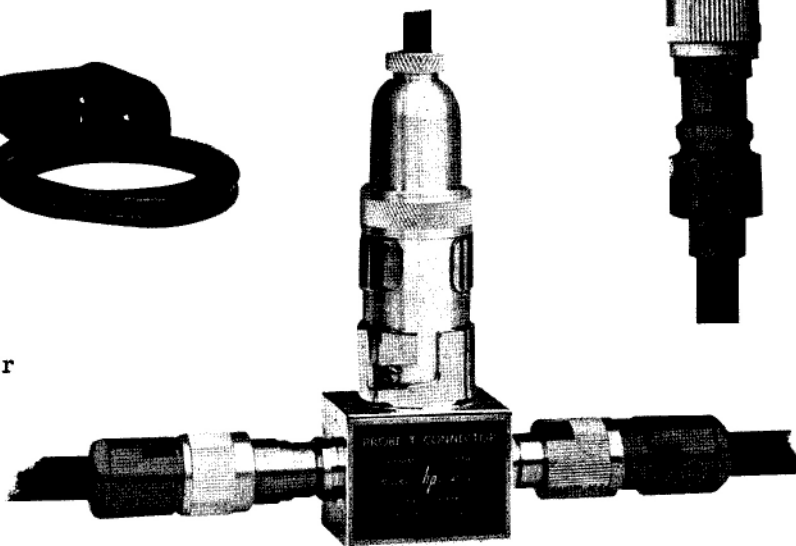
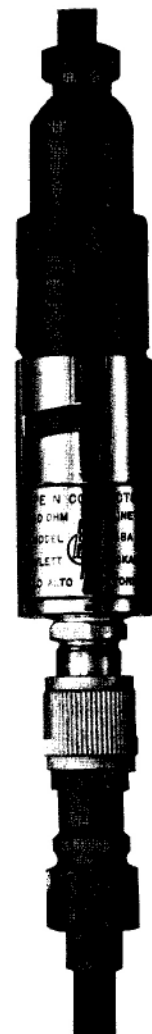

1-2b  Model 452A
Capacitive Voltage Divider
and 452A-95A Adaptor

1-2c  Model 458A
Probe Coaxial "N"
Connector



1-2d  Model 455A Coaxial "T" Connector



1-2e  Model 459A DC Resistive Voltage Multiplier

Figure 1-2. Accessories for Model 410B

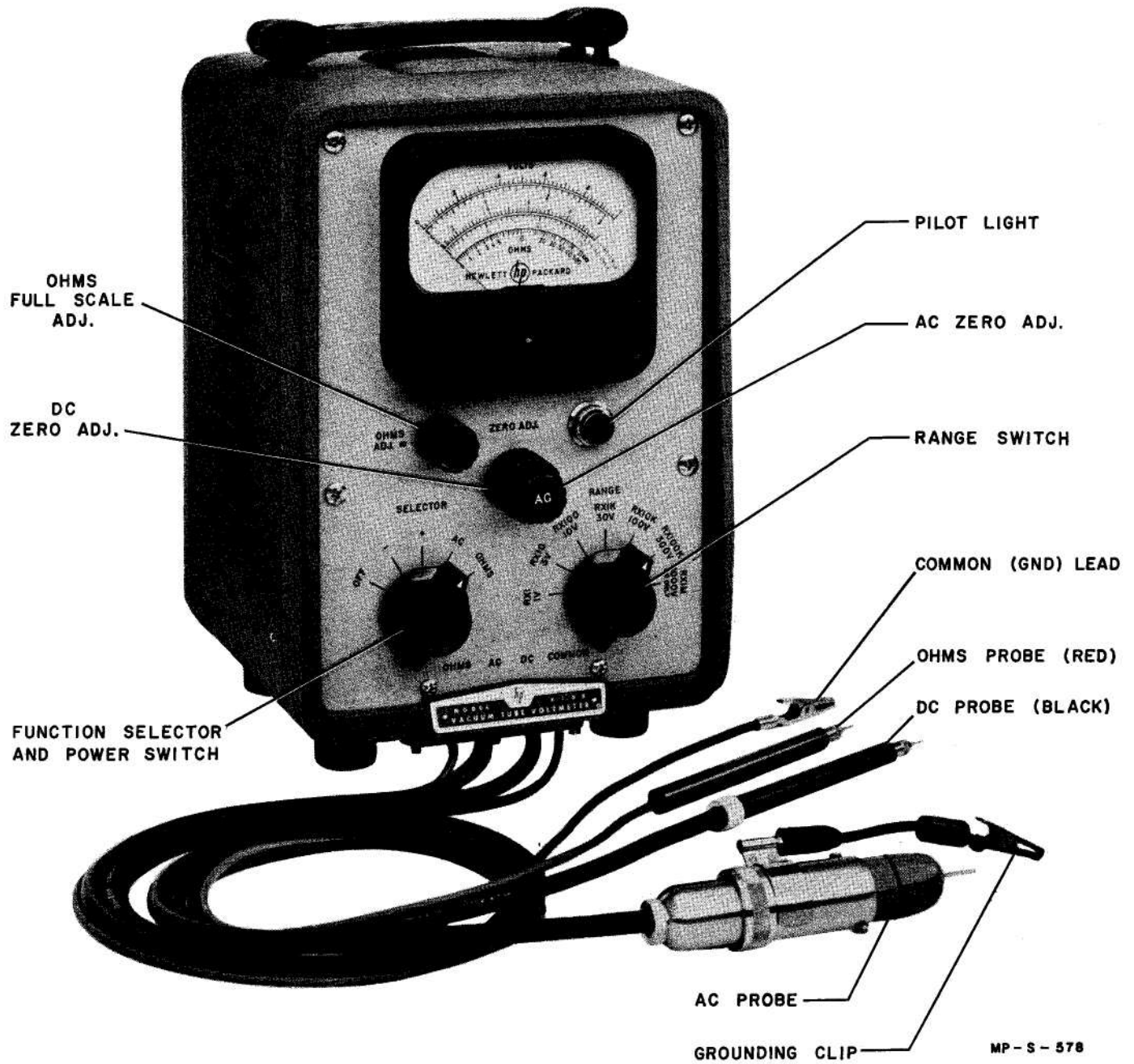

Figure 2-1. Model 410B Controls and Terminals Labeled

SECTION II

OPERATING INSTRUCTIONS

2-1 OPERATING CONTROLS AND TERMINALS

A description of each of the front panel controls, the test probes, and the meter follows:

SELECTOR - This five-position switch turns the instrument on; provides for measurements of negative or positive d-c voltage, a-c voltage, or resistance; and connects the appropriate probe for the desired measurement.

RANGE - This switch selects the full-scale voltage or resistance range to be used.

ZERO ADJ. - The larger, fluted knob is a basic zero adjustment that sets the meter pointer to zero when the SELECTOR switch is set at - and +. The smaller knob marked AC is used to set the meter pointer to zero following the basic zero adjustment and with the SELECTOR switch set to AC.

OHMS ADJ. ∞ - This knob adjusts the meter pointer to full scale (∞) when the SELECTOR switch is set to OHMS.

OHMS, AC, DC, COMMON - The designation at the bottom of the control panel identify the various test leads, which are connected underneath the instrument. The connector can be removed by unscrewing the two captive round head screws in either end of the connector. Once installed, the three probes need not be removed, although only the one probe in use is connected through the SELECTOR switch to the internal circuits. Each probe has the specialized function described below.

OHMS - The red rubber-covered cable with the red plastic prod is used in measuring resistance. The prod is equipped with a small chuck to hold a steel phonograph needle. The instrument is shipped from the factory with the sharp point of the needle inside the chuck and can be reversed if it is necessary to employ a sharp point for good connection.

The probe is the negative side of the internal voltage source used for resistance measurements.

AC - A cable that terminates in the shielded probe is used for ac voltage measurements. The probe tip contacts the point in a circuit where a voltage is to be measured and the clip lead on the probe connects to the ground side of the circuit.

DC - The black, shielded cable with the black plastic prod is used to measure d-c voltages. The prod is equipped with a small chuck to hold a steel phonograph needle. The instrument is shipped from the factory with the sharp point of the needle inside the chuck and can be reversed if it is necessary to employ a sharp point for good connection.

COMMON - The black rubber-covered wire terminated in an alligator clip is the negative connection for all measurements except those made with the clip lead on the end of the AC probe. The common lead is connected directly to the chassis of the instrument and to the third grounding conductor in the power cable. When making resistance measurements this lead is positive with respect to the red prod.

FUSE - The fuseholder, located behind the cover in the rear compartment of the instrument, contains a 0.6 amp slow-blow, 115 volt line cartridge fuse replaceable by unscrewing the fuseholder cap and inserting a new fuse. A 0.25 amp slow-blow fuse should be used if the instrument is operated on 230 volts.

2-2 OPERATING ADJUSTMENTS

The  Model 410B has three front panel operating adjustments: ZERO ADJ., AC ZERO ADJ., and OHMS ADJ. ∞ . ZERO ADJ. sets the meter pointer to zero when the selector switch is in the - and in the + positions and must be adjusted before the AC and the OHMS adjustments are made. AC ZERO ADJ. adjusts the meter pointer to zero when the selector switch is in the AC position to compensate for any small residual meter reading that appears as the a-c probe is switched into operation. The

AC ZERO should be adjusted when the range switch is on the 1 volt range. OHMS ADJ. ∞ sets the meter pointer to full-scale when the selector switch is turned to the OHMS position.

2-3 STEP-BY-STEP OPERATING PROCEDURES

A. Basic Zero Adjustment

- 1) Connect the power cable to the power line. Set the SELECTOR switch to the (-) position and allow instrument to heat for five minutes for stable operation.
- 2) Connect the DC and COMMON test leads together. Adjust the ZERO ADJ. (outer concentric knob) control so that the meter indicates zero with the RANGE switch set to the 1 volt range.
- 3) Set the SELECTOR switch to + and note the meter reading. If the needle point has shifted, set ZERO ADJ. so that the needle returns to the same position for both - and + positions of the SELECTOR switch.
- 4) Proper zero set is indicated when the meter zero does not shift when the SELECTOR switch is changed from (+) to (-) and back.

B. AC Zero Adjustment

- 1) Make the Basic Zero Adjustment described above.
- 2) Set the SELECTOR switch to AC and set the RANGE switch to the 1 volt position.
- 3) Connect the AC probe clip lead to the probe tip.
- 4) Adjust the AC knob to bring the meter pointer to 0.

C. OHMS Full-Scale and Zero Adjustment

- 1) Make the Basic Zero Adjustment described above.
- 2) Set the SELECTOR switch to OHMS.
- 3) Adjust the OHMS ADJ. ∞ control so that the meter pointer indicates ∞ on the ohms scale. The OHMS and COMMON test leads must not be connected together when making this adjustment.
- 4) To use the ohmmeter without making the basic zero or AC adjustment, connect the OHMS and COMMON test leads together, set the RANGE switch to RX1K or higher range, and adjust the ZERO ADJ. (outside concentric knob) until the meter pointer indicates zero on the ohms scale.

- 5) With the OHMS test lead not shorted, set the OHMS ADJ. ∞ knob to bring the pointer to ∞ .

The multimeter is now ready for operation. Before attempting to make an actual measurement, study the operating procedures described in the paragraphs below.

CAUTION

The voltmeter COMMON, the AC PROBE ground clip lead, the instrument chassis and cabinet are all electrically tied together at all times. In addition, the third (green) lead in the power cable is tied to the chassis. If the three prong NEMA connector is used in a proper mating receptacle, the 410B will be connected to the power system ground. When making voltage measurements, ac or dc, positive or negative, always connect the voltmeter COMMON or the AC PROBE ground clip lead to the chassis, or ground, of the equipment under test. Connecting the ground clip to any other point will automatically ground that point to the power system ground. If a ground path in the equipment under measurement also exists to the power ground, a short circuit will result. If a three-prong to two-prong adapter is used with the pig-tail ground lead disconnected, the cabinet of the 410B will assume the same potential as the point to which the clip lead is connected. For safety's sake, it is best not to make measurements with the ground clip lead connected to points not at chassis potential. In almost every case the measurement can be made successfully by reading the voltages with respect to ground and then subtracting one reading from the other.

2-4 PROCEDURE FOR MEASURING DC VOLTAGES

- a. Make the basic zero adjustment described earlier in paragraph 2-3.
- b. Set the SELECTOR switch to either the (+) or (-) position, depending upon the polarity of the voltage to be measured.
- c. Set the RANGE switch to the range that includes the voltage to be measured.
- d. Connect the COMMON test lead to the ground side of the circuit to be measured and touch the DC VOLTS prod to the point in the circuit being measured.
- e. Read the measured voltage from the meter, multiplying the indicated value by the appropriate factor. Dc voltages are read from the two top meter scales, 0-1 and 0-3, printed in black.

2-5 PROCEDURES FOR MEASURING AC VOLTAGES

- Make the AC ZERO adjustment described above.
- Set the RANGE switch to the range that includes the voltage to be measured.

CAUTION: The ac probe blocking capacitor is rated at 500 volts, do NOT connect the ac probe to higher voltages. Before measuring voltages above 50 megacycles, consult Figure 2-2 a graph of maximum applied voltage vs. frequency. Certain other precautions apply to ac voltage measurements, they are discussed in paragraph 2-8.

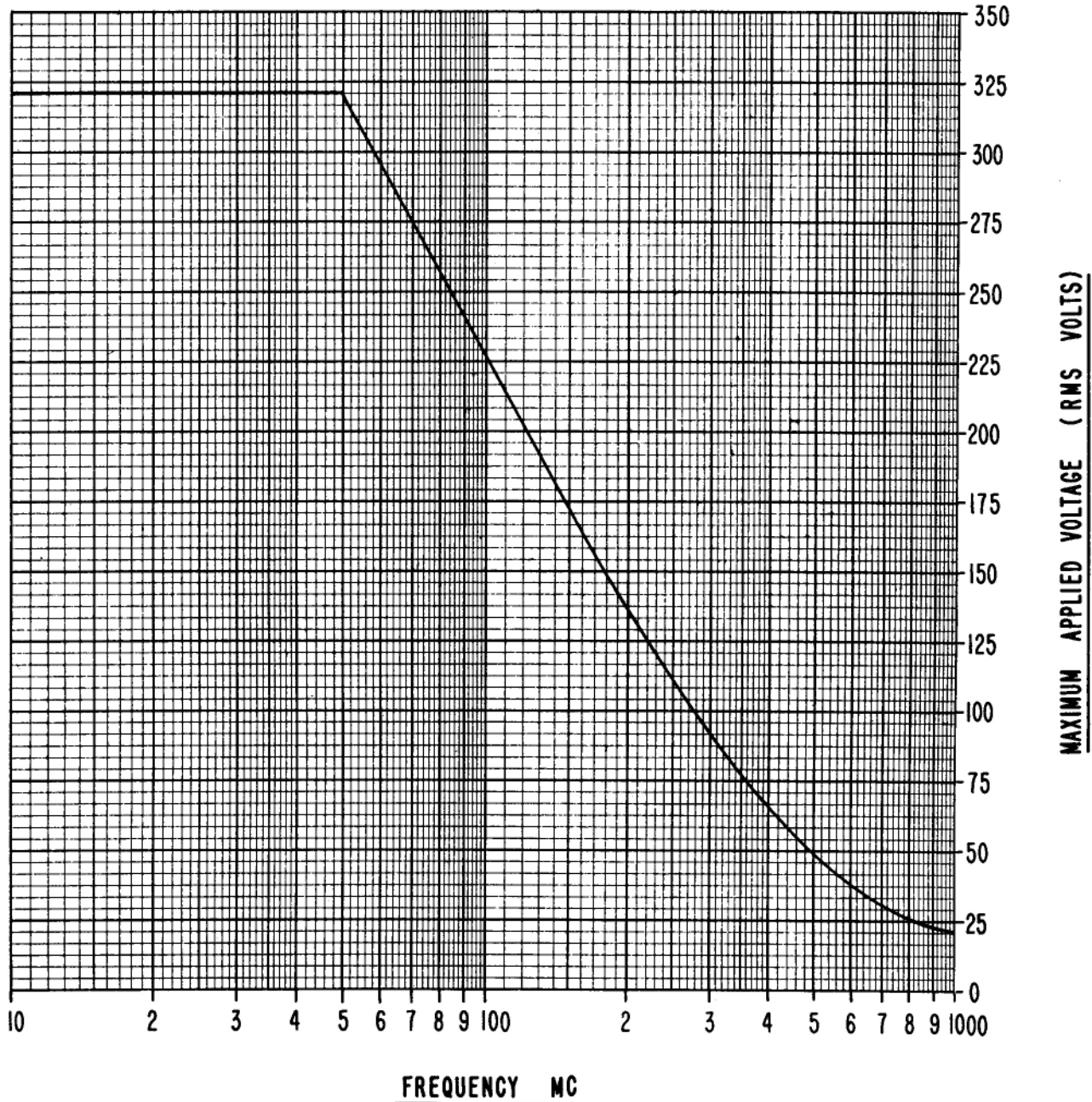

Figure 2-2. Maximum Voltage that can Safely be applied to AC Probe for Frequencies above 50 Megacycles

c. Connect the ground clip lead on the a-c probe to ground of the circuit being measured and touch the a-c probe tip to the other side of the circuit being measured. (For audio frequencies the ground lead from the voltmeter chassis may be used for negative connection instead of the ground lead on the a-c probe, if desired.)

d. The measured voltage is then read from the meter. The full-scale value of the meter is indicated by the setting of the RANGE switch.

NOTE

The 0 - 1V and 0 - 3V meter scales printed in red are for use only with the 1V and 3V a-c positions of the RANGE switch. The remainder of the alternating voltage ranges are read from the two top meter scales (0 - 1 and 0 - 3) printed in black.

2-6 PROCEDURE FOR MEASURING RESISTANCES

CAUTION

TURN OFF EQUIPMENT THAT IS TO BE TESTED BEFORE MAKING RESISTANCE MEASUREMENTS. Be certain that no residual voltages remain in the circuit being measured. When making a leakage resistance measurement on paper capacitors on the RX1Meg range, a reading of greater than ∞ is sometimes measured with the OHMS leads connected one way and a fairly low value of resistance will be measured with the OHMS leads reversed. This is caused by a surface charge in the dielectric of the capacitor which leaks out after the capacitor is first discharged and builds up another slight voltage across the terminals. Since the 410B operates at a very high im-

pedance level, this small voltage will cause erroneous resistance readings. Generally, keeping the capacitor terminals shorted for a few minutes will reduce this charge to zero and a correct reading can be made. This phenomenon will not occur on any of the lower ranges.

- a. Make the OHMS adjustment described in paragraph 2-3C.
- b. Set the SELECTOR switch to the OHMS position.
- c. Connect the COMMON and OHMS test leads to the resistance to be measured.
- d. Set the RANGE switch to the position that gives the largest up-scale meter indication.
- e. Read resistance value from bottom scale on meter. The resistance is equal to the scale indication times the multiplying factor shown by the position of RANGE selector.
- f. Resistance readings up to a million megohms or higher are possible with an external battery. Refer to paragraph 2-10 for details.

2-7 ELECTRICAL CHARACTERISTICS OF THE DIODE AND PROBE

The ϕ Model 410B measures a-c voltages from 1 volt full-scale to 300 volts full-scale in the frequency range from 20 cycles to 60 megacycles and measures reduced voltages to 700 megacycles. The basic accuracy is $\pm 3\%$ for measurement of sine waves up to 60 megacycles per second, while the frequency response is ± 1 db over the entire frequency range

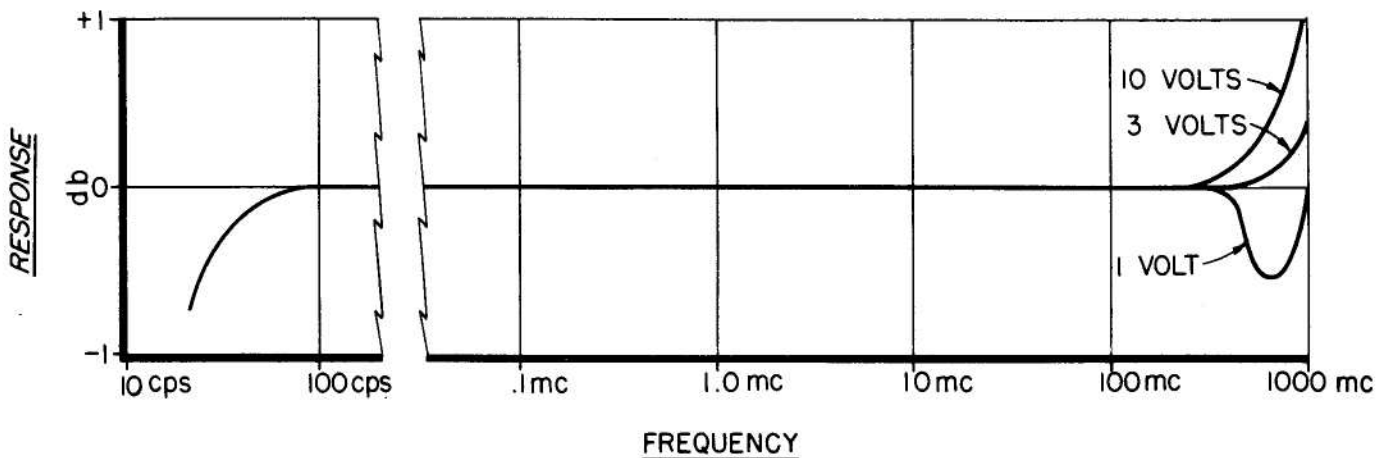

Figure 2-3. Ratio of Indicated to Actual Voltage as a Function of Frequency

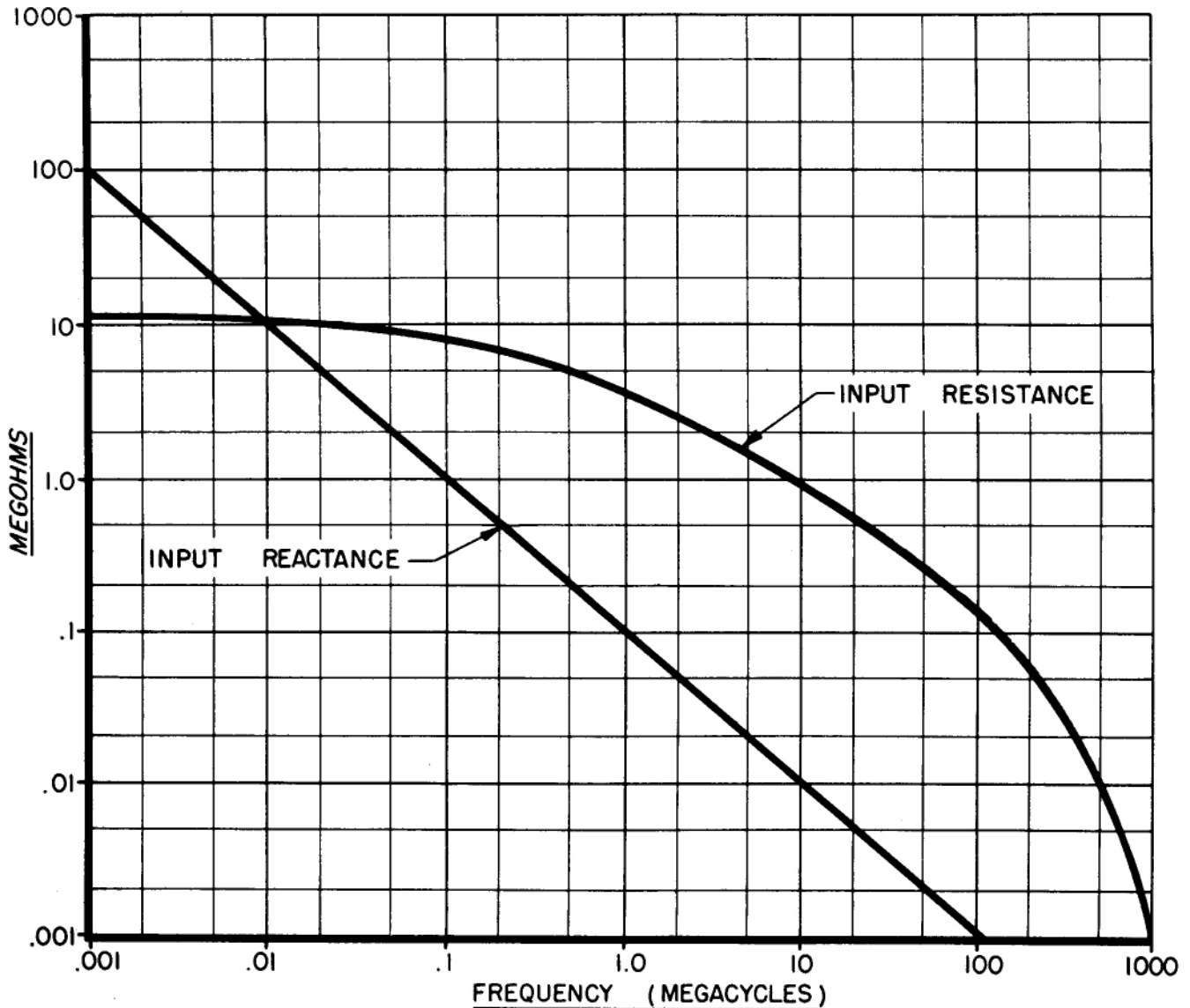

Figure 2-4. Input Resistance and Reactance of Model 410B Diode Probe

from 20 cycles to 700 megacycles per second. The 410B continues to be useful up to the probe resonant frequency of approximately 1250 megacycles, and indications can be obtained up to 3000 megacycles.

A performance curve for the probe, showing the ratio of indicated to actual voltage as a function of frequency, is plotted in Figure 2-3. At low and medium frequencies the response is flat. At high frequencies, however, the response is affected by two factors: transit time of the probe diode, which is dependent upon the magnitude of the applied voltage; and the resonant frequency of the probe, which is independent of the applied voltage. The effect of

transit time is indicated by the dip in the 1-volt curve in the vicinity of 500 mc. The rise of the 3-volt and 10-volt curves is due to the effects of resonance in the probe, which overshadow the effects of transit time.

The input resistance and shunt capacitive reactance components in the circuit within the a-c probe are shown in the graph Figure 2-4. At low frequencies the input resistance exceeds 10 megohms, decreasing at higher frequencies because of dielectric and tube losses. The shunt capacity component of input impedance is approximately 1.5 micromicrofarads.

2-8 AC MEASUREMENT PRECAUTIONS

Special considerations must be kept in mind when making a-c voltage measurements. These considerations are discussed in the following paragraphs.

a. General Consideration of Complex Waveforms

Waveforms containing appreciable harmonics or spurious voltages will introduce errors in the meter indication since the meter has been calibrated to read rms values of true sine waves while the a-c probe is a peak-responding device. The magnitude of error that may be expected when harmonics are present on the measured waveform is indicated in the Table below.

Table 2-1. Possible Error when Measuring Voltage of Complex Waveforms

% Harmonic	True RMS Value	Model 410B Indication
0	100	100
10% 2nd	100.5	90 to 110
20% 2nd	102	80 to 120
50% 2nd	112	75 to 150
10% 3rd	100.5	90 to 110
20% 3rd	102	87 to 120
50% 3rd	112	108 to 150

b. Voltage Measurements at Frequencies below 50 Cycles/Second - Voltage measurements

at frequencies as low as 10 cycles per second may be made to the unit's basic accuracy by removing the plastic nose on the a-c probe and using in its place a blocking capacitor of 0.25 microfarad in series with the exposed contact of the probe.

CAUTION: The gray insulating material of the probe of the 410B is polystyrene, a low melting-point material. It is not possible to solder to the contact which is exposed when the probe nose is removed without destroying the polystyrene.

c. Voltage Measurements at High Frequencies

At frequencies above 100 megacycles the distance between the point of voltage measurement and the anode contact of the a-c probe must be made as short as possible. If feasible, substitute a small button-type capacitor of approximately 50 micromicrofarads for the removable tip on the a-c probe. Solder one terminal of the button capacitor to the measurement point in the circuit and not to the probe contact. The probe contact (with tip removed) can then contact the other terminal of the capacitor for the measurement.

At frequencies above 100 megacycles considerable voltage may be built up across ground leads and along various parts of a grounding plane. Consequently, to avoid erroneous readings when measure-

ing medium and high frequency circuits, use the ground clip lead on the shell of the probe. In some cases at the higher frequencies it may be necessary to shorten still further the grounding lead on the shell of the probe.

For all measurements at the higher frequencies hold the molded nose of the probe as far from the external ground plane or from objects at ground potential as can conveniently be done. Under typical conditions, this practice will keep the input capacitance several tenths of a micromicrofarad lower than will be obtained otherwise.

For a-c measurements above approximately 250 megacycles it is nearly mandatory that measurements be made on voltages which are confined to coaxial transmission line circuits. For applications of this type, the Φ Model 410B is particularly suitable because the physical configuration of the diode and probe is that of a concentric line, and with a few precautions it can be connected to typical coaxial transmission line circuits with little difficulty.

To connect the Φ Model 410B into an existing coaxial transmission line, cut the line away so the center conductor of the line is exposed through a hole large enough to clear the body of the voltmeter a-c probe. The nose of the probe should be removed for this type of measurement. Connect one terminal of a button-type capacitor of approximately 50 micromicrofarads to the center conductor of the coaxial line so that the other terminal of the capacitor will contact the anode connection of the probe. A close-fitting metal shield or bushing should be arranged to ground the outer cylinder of the probe to the outer conductor of the transmission line. This type of connection is likely to cause some increase in the standing wave ratio of the line at higher frequencies. The Φ Model 455A Coaxial "T" Connector is designed to do this job with a vswr of less than 1.1 at 500 mc. See paragraph 1-5.

d. Effect of Parasitics on Voltage Readings -

At frequencies above 500 megacycles, leads or portions of circuits often resonate at frequencies two, three or four times the fundamental of the voltage being measured. These harmonics may cause serious errors in the meter reading. Owing to the resonant rise in the probe circuit at frequencies above 1000 megacycles, the meter may be more sensitive to the harmonics than to the fundamental. To make dependable measurements at these frequencies, the circuits being measured must be free of all parasitics.

e. Effect of DC Present With AC Signal -

When measuring small ac voltages, which are present at a point along with high dc potential, you may obtain a voltage reading which is in error. This is caused by a very small leakage current through the blocking capacitor in the tip of the ac probe, and

might occur when you attempt to measure a 1 volt ac signal at the plate of a vacuum tube.

If this leakage is a problem you should add an external blocking capacitor ahead of the probe tip. A Mylar or polystyrene dielectric capacitor of 0.005 μ f or larger is recommended. The usual paper or ceramic capacitor will not have sufficiently high leakage resistance to eliminate the problem.

Factory specifications require that the probe tip blocking capacitor have not less than 100,000 megohms resistance, which is the highest value obtainable in a part that meets other requirements. This is very high, but still makes a 1000:1 voltage divider with the 122 megohms input resistance of the meter circuits when on the 1 volt ac range. A 100 volt dc potential will be divided down and will present (approximately) a 0.1 volt signal to the meter circuit. On higher ac ranges, the effect is reduced proportionately.

2-9 PULSE MEASUREMENTS

The 410B is a peak-responding rms calibrated type voltmeter and is designed to measure the positive peak value of the applied voltage. This property allows the Φ Model 410B to be used to measure the positive voltage amplitude of a pulse, provided the reading obtained is multiplied by the following factor:

$$1.4 \left(1 + \frac{t_1}{t_2} + \frac{K}{\text{PRF}} \right)$$

where: t_1 is the duration of the positive portion of the voltage in microseconds,
 t_2 is the duration of the negative portion of the voltage,
 K is a factor which is a function of the source impedance of the pulse generator and of t_1 , and is found in the graph of Figure 2-5.
 PRF is the pulse repetition frequency in pulses per second.

In general this equation is applicable where the pulse repetition frequency is greater than 500 pulses per second and the positive pulse duration is at least 10 microseconds. For most cases when using high pulse repetition rates, the above factor will reduce to

$$1.4 \left(1 + \frac{t_1}{t_2} \right)$$

K can be found by use of the curve in Figure 2-5 when the impedance of the pulse generator R_0 in kilohms and the duration of the positive portion of the pulse t_1 in microseconds are known.

As an example, suppose:

$t_1 = 10$ microseconds,
 $R_0 = 2$ kilohms and the pulse repetition frequency is 1000 pulses per second,

then $R_0/t_1 = 0.2$, $K = 0.55$, and the multiplying factor would then be

$$1.4 \left(1 + \frac{10}{990} + \frac{0.55}{1000} \right).$$

For the case of a 10 microsecond negative pulse and a pulse repetition frequency of 1000 pulses per second, t_1 would be 990 microseconds and t_2 would equal 10 microseconds. Thus, R_0/t_1 would be approximately 0, and therefore (from Figure 2-5) K would also be approximately 0. The multiplying factor would then be

$$1.4 \left(1 + 990/10 \right).$$

Hence, it may be seen that in the case of negative pulses of short duration much smaller readings will be obtained than for an equivalent positive pulse. As a result, large multiplying factors must be used and unless the pulse voltage is large, these measurements may be impractical.

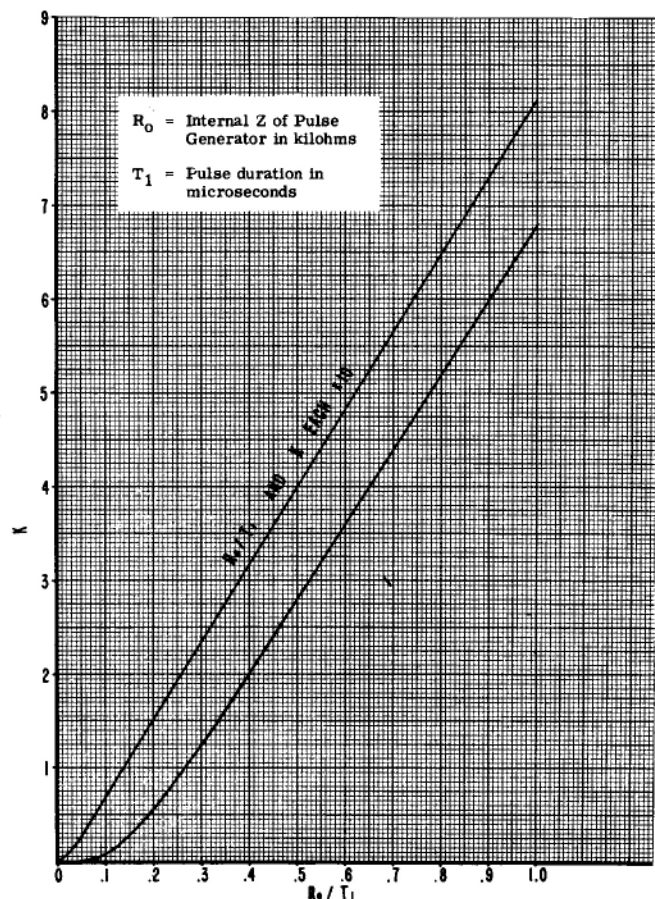

Figure 2-5. Graph used in Calculation of Pulse Voltages

2-10 RESISTANCE MEASUREMENT ABOVE 500 MEGOHMS

Because of its very high input resistance the Model 410B, supplemented by an external voltage, can be used to measure extremely high resistances. Any convenient d-c voltage up to 1000 volts may be used, the higher voltages permitting measurement of higher resistances. A 45-volt "B" battery extends the resistance measurement range to approximately 250,000 megohms. Resistances as high as several million megohms are easily and accurately made when the leakage between the test leads is held to a minimum by careful placement. The highest resistance that can be measured is limited by the total leakage between the DC test probe and the COMMON test probes on the voltmeter.

The measurement of extremely high resistance is accomplished by applying a known d-c voltage to the unknown resistance in series with the 410B as shown in Figure 2-6. The external voltage is first measured with the 410B and recorded. The positive side of the external voltage source is then connected through unknown resistance to the d-c measurement probe, the negative side of the voltage is connected

to the COMMON lead from the 410B. The voltmeter range switch is then adjusted to obtain an upscale voltage reading. The meter indicates the voltage across the 122 megohm input resistance, which when multiplied by the ratio of the applied voltage to the measured voltage, minus one, gives the resistance of the unknown. The equation for determining an unknown resistance for any supply voltage and meter reading is given in the following equation. When the ratio of E applied to E measured is greater than 100:1, the minus one may be dropped with no practical loss in accuracy.

$$R_x = \left(\frac{E_{bb}}{E_m} - 1 \right) R_m$$

E_{bb} = Externally applied battery or power supply voltage

E_m = Voltage read on d-c volts scale of voltmeter

R_m = Input resistance of voltmeter

(410A = 100 megohms)

(410B = 122 megohms)

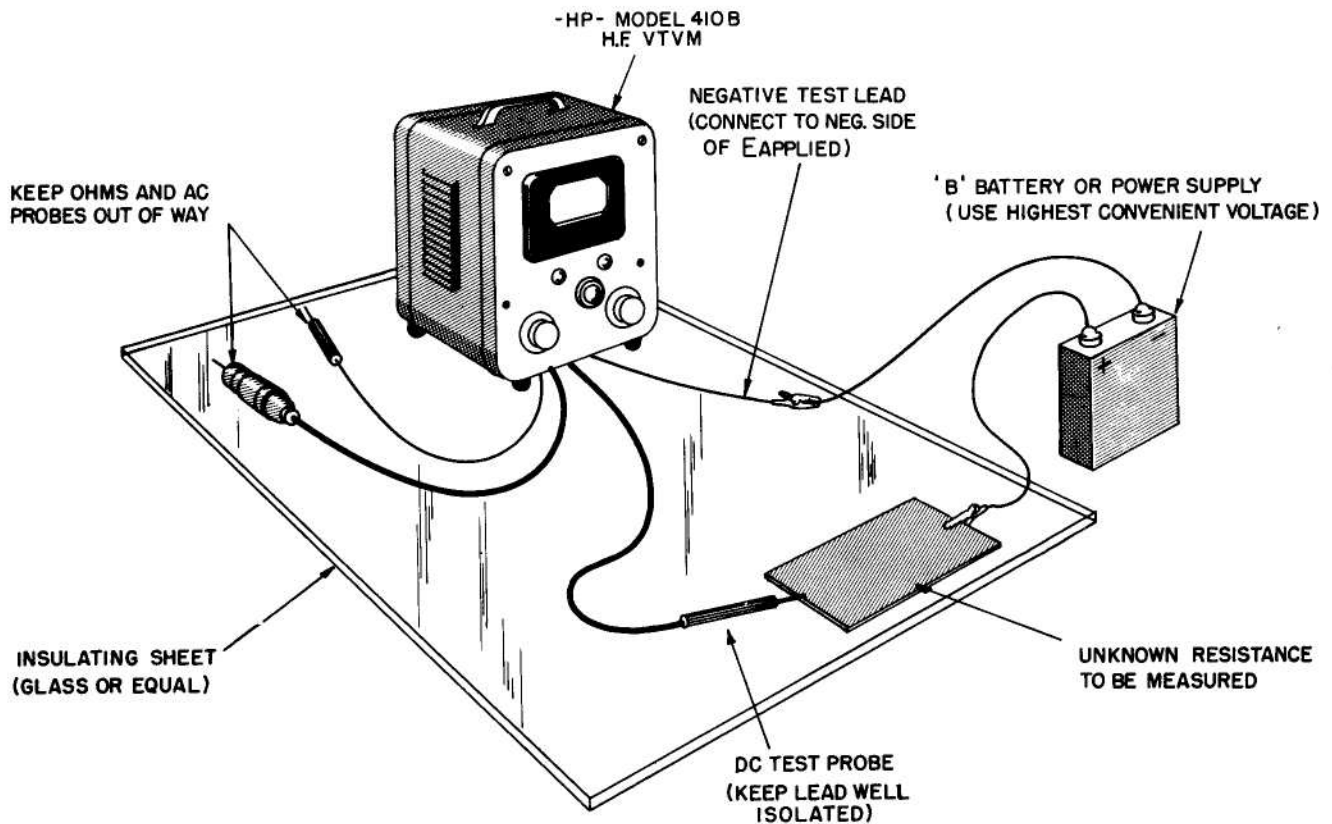

Figure 2-6. Setup for Measuring Extremely High Values of Resistance

SECTION III THEORY OF OPERATION

3-1 GENERAL

The Φ Model 410B is designed to measure the amplitude of a-c and d-c voltages and the values of resistances. To accomplish these measurements, the equipment's circuit is arranged as indicated by the block diagram of Figure 3-1. When measuring d-c voltages, the voltage to be measured is applied through a precision voltage divider to the input of a differential d-c amplifier. The output of the ampli-

fier feeds a balanced bridge which has an indicating meter connected between the mid-points. The magnitude of deflection of the meter is thus proportional to the amplitude of the d-c voltage applied to the input of the differential amplifier.

When measuring a-c voltages, the voltage to be measured is converted to a d-c voltage in a special wide-band rectifier circuit. The output of the rectifier is then applied to the d-c voltage-measuring

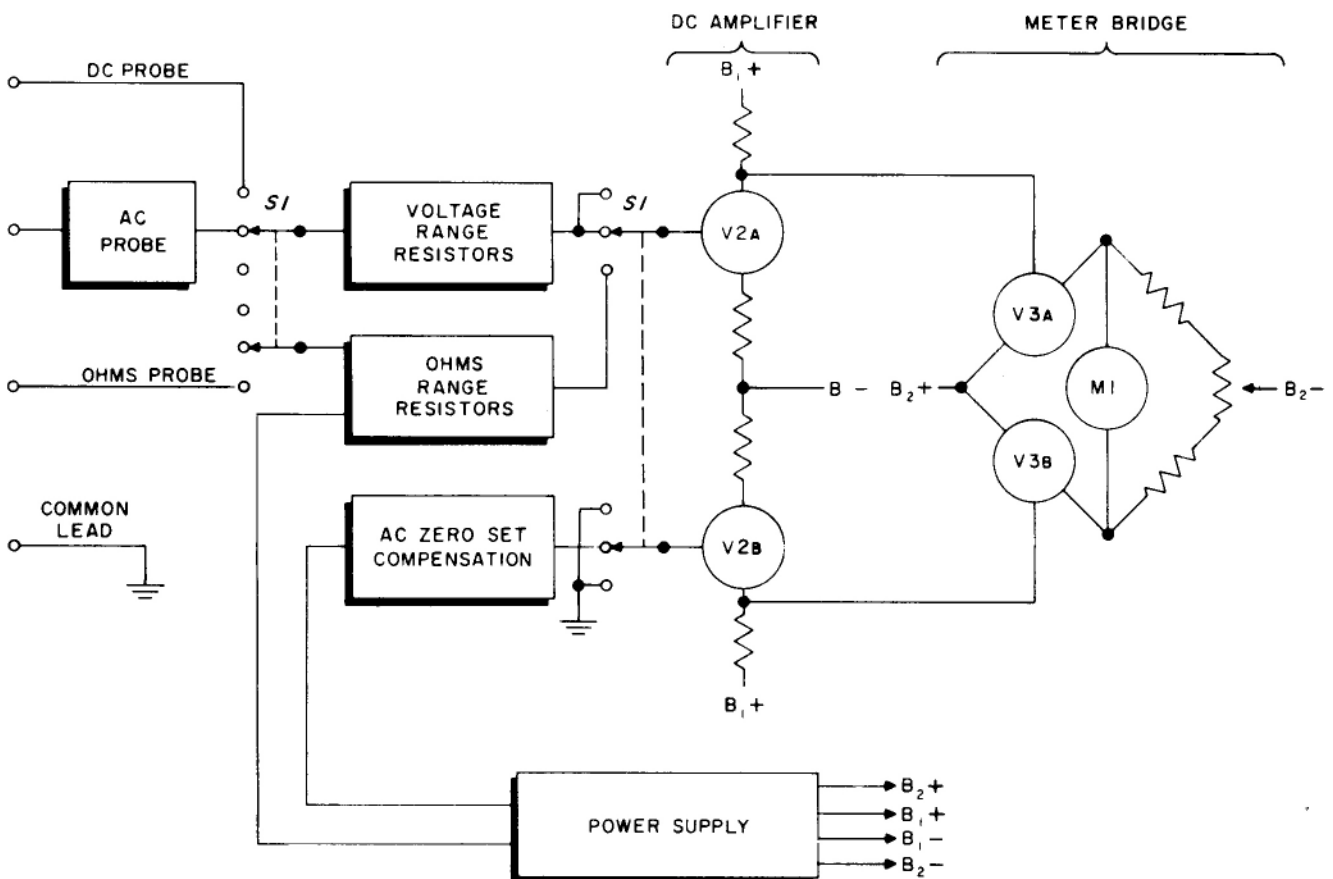

Figure 3-1. Block Diagram of Φ Model 410B

circuit described above. A deflection of the indicating meter then occurs in proportion to the amplitude of the a-c voltage being measured.

For measuring resistance, a d-c voltage from the voltmeter power supply is applied through a large resistance to form a constant current source. This supplies a circuit consisting of the unknown resistance connected in parallel with a known resistance. The proportion of the internal voltage that appears across the unknown resistance is related to the ratio of the unknown to the known resistance. The voltage across the unknown resistance is then applied to the input of the differential amplifier as before, with the result that the magnitude of meter deflection is related to the value of the resistance being measured.

3-2 R-F RECTIFIER

The circuit used for rectifying a-c signal voltages is shown in Figure 3-2. The circuit is a half-wave shunt-detector type circuit which operates to charge the small input coupling capacitor C1 to the peak value of the positive half of the a-c voltage being measured. To smooth the rectified a-c voltage for application to the differential amplifier, a large resistor (22 megohms) and capacitors C2 and C3 are connected across the output of the rectifier. The voltage across the capacitors rises to the peak value of the rectified wave and is applied through the precision voltage divider to the d-c amplifier.

Since the voltmeter is designed to be capable of measuring high frequencies, the rectifier circuit is built in the form of a probe so that it can be physically placed close to the point of measurement. The probe connects to the voltmeter proper through a flexible cable.

This arrangement permits short lead lengths for the actual a-c portion of the measuring circuit so that residual inductances will be minimized.

A cutaway view of the a-c probe showing the input blocking capacitor, rectifier diode, and RC filter

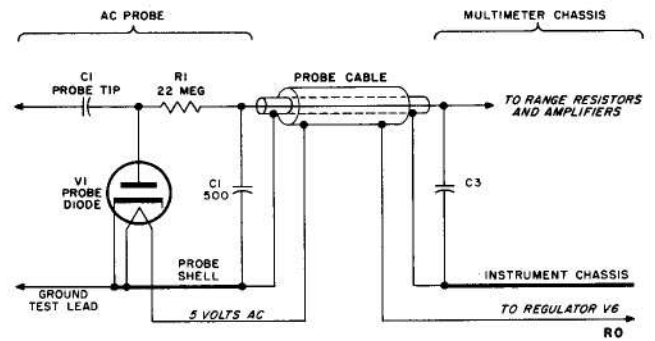

Figure 3-2. Schematic Diagram of AC Probe

is shown in Figure 3-3. The input capacitor is molded in a removable probe tip for applications where even the small lead length of the tip should be minimized. The diode is specially designed to have plane rather than circular geometry. This type of construction has been used in order to reduce the physical length of the diode and to achieve a diode having extremely low anode-cathode capacity. The construction is such that the probe has an input capacity of only about 1.5 mmf, about 1.3 of which is the anode-cathode capacity of the diode. To achieve short transit time for the diode, the anode-cathode spacing has been maintained at only .003 inch. Reliable r-f grounding of the diode cathode is obtained by use of a large area contact ring in the special socket for the diode. Figure 3-4 shows a line drawing of the probe diode.

The capacity in the RC filter is divided into two parts. A small 500 mmf capacitor, C2, is built into the probe near the base of the diode. At high frequencies this capacitor in combination with the 22-megohm filter resistor gives sufficient filtering so that the inductance of the flexible cable is of no consequence. For lower frequency filtering, Capacitor C3, is connected at the end of the cable inside the multimeter housing.

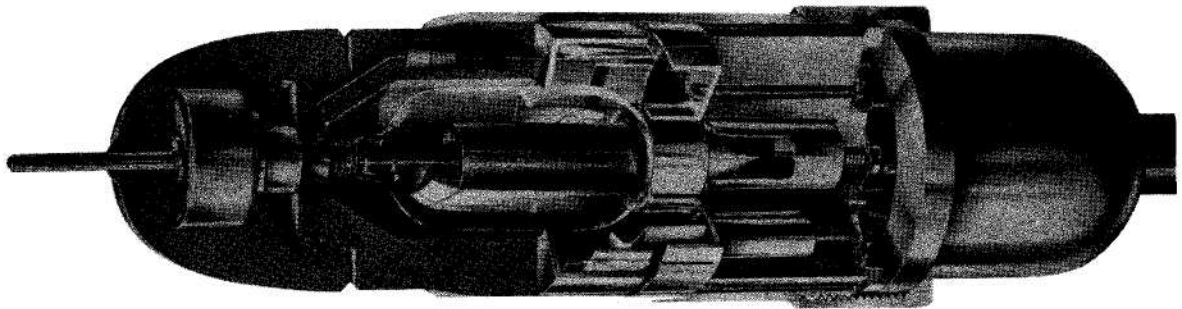

Figure 3-3. Cutaway View of High-Frequency Probe

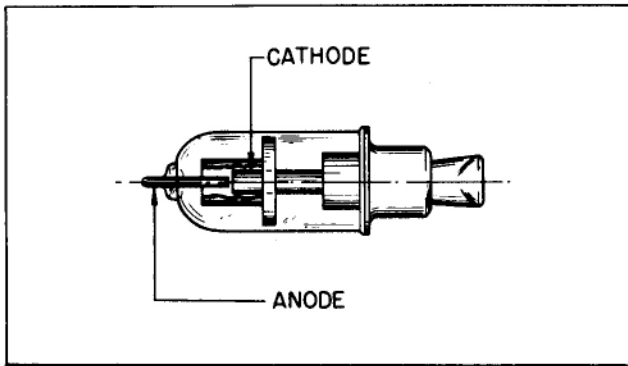

Figure 3-4. Actual Size Drawing of High-Frequency Diode

The probe is constructed from molded polystyrene to offer a low dielectric loss which, together with the low input capacity, makes the probe a high impedance device. The input impedance of the probe as a function of frequency is given in Figure 2-4.

The flexible cable connecting the probe to the voltmeter is a double-shielded single conductor cable. The outside shield carries a-c power for the diode heater; the inner lead carries the d-c voltage from the RC filter to the voltmeter. Ground return is made through the inner shield.

3-3 RANGE EXTENDING RESISTORS

To extend the voltage range over which both a-c and d-c measurements can be made, a precision voltage divider is connected to the input of the d-c amplifier. The taps on the divider are arranged so that the input to the amplifier does not exceed approximately .85 volt for a full-scale reading on d-c voltage measurements. On a-c measurements approximately 1.17 volts is applied to the amplifier for a full-scale reading. This increased voltage on a-c measurements is compensated by resistors in series with the indicating meter, as described later.

The precision voltage divider is made up of high-stability deposited carbon type resistors mounted on a seven-position rotary switch which serves as the range switch for the instrument.

3-4 DC AMPLIFIER

The taps on the precision voltage divider connect through the range switch to one input of the differential voltage amplifier. The amplifier consists of the two halves of a 12AU7 twin triode. The principle

purpose of this amplifier is to serve as an impedance transformer between the 100-megohm impedance level in the range switch and the meter circuits. To achieve a high input impedance for the amplifier, it is operated without a grid resistor other than the 100-megohm voltage divider and at a low plate current in the order of a couple of microamperes. Gas current effects in the high grid impedance are minimized by operating the amplifier tubes at a reduced heater voltage and a low plate voltage (approximately 20 volts). Very large cathode resistances are used to enhance the stability of the amplifier.

For a-c measurements the second or "balance" input to the differential amplifier is connected to a source of small d-c voltage in the power supply circuit. This arrangement is designed to compensate the voltmeter for "emission voltages" that occur in the probe diode. Because of the high thermal level of the probe diode cathode, electrons are emitted by the cathode even though no signal voltage is applied to the diode anode. Some of these electrons travel to the anode, giving it a net negative potential of approximately 1 volt, which will mask small signal voltages applied to the diode.

To compensate for this effect, the d-c voltage applied to the second input of the d-c amplifier is adjusted to be equal to the emission voltage of the diode. A voltage divider in the balance channel divides the compensating voltage in the same proportion as the input range switch divides the emission voltage so that the amplifier will always be compensated when the a-c probe is connected. The AC zero set control on the front panel adjusts the compensating voltage to exactly balance the voltage produced by the diode thereby bringing the meter to zero.

For d-c measurements the second input to the differential amplifier is grounded and serves only to supply a d-c level to balance the bridge.

3-5 METER CIRCUIT

The double-ended output of the differential amplifier is applied to a bridge circuit across which is connected the indicating meter, as illustrated by the diagram in Figure 3-5. Two arms of the bridge are triode tubes whose grids are connected to the two sides of the differential amplifier. With no voltage being measured, the two triodes have equal grid potentials and the bridge is in a balanced state. The front panel ZERO SET control R19a, a potentiometer located between the two legs of the bridge and the d-c supply voltage, establishes the exact electrical balance of the bridge for all types of operation. Potentiometer R32 is connected in series with the meter to adjust the sensitivity of the meter circuit to the precise required value.

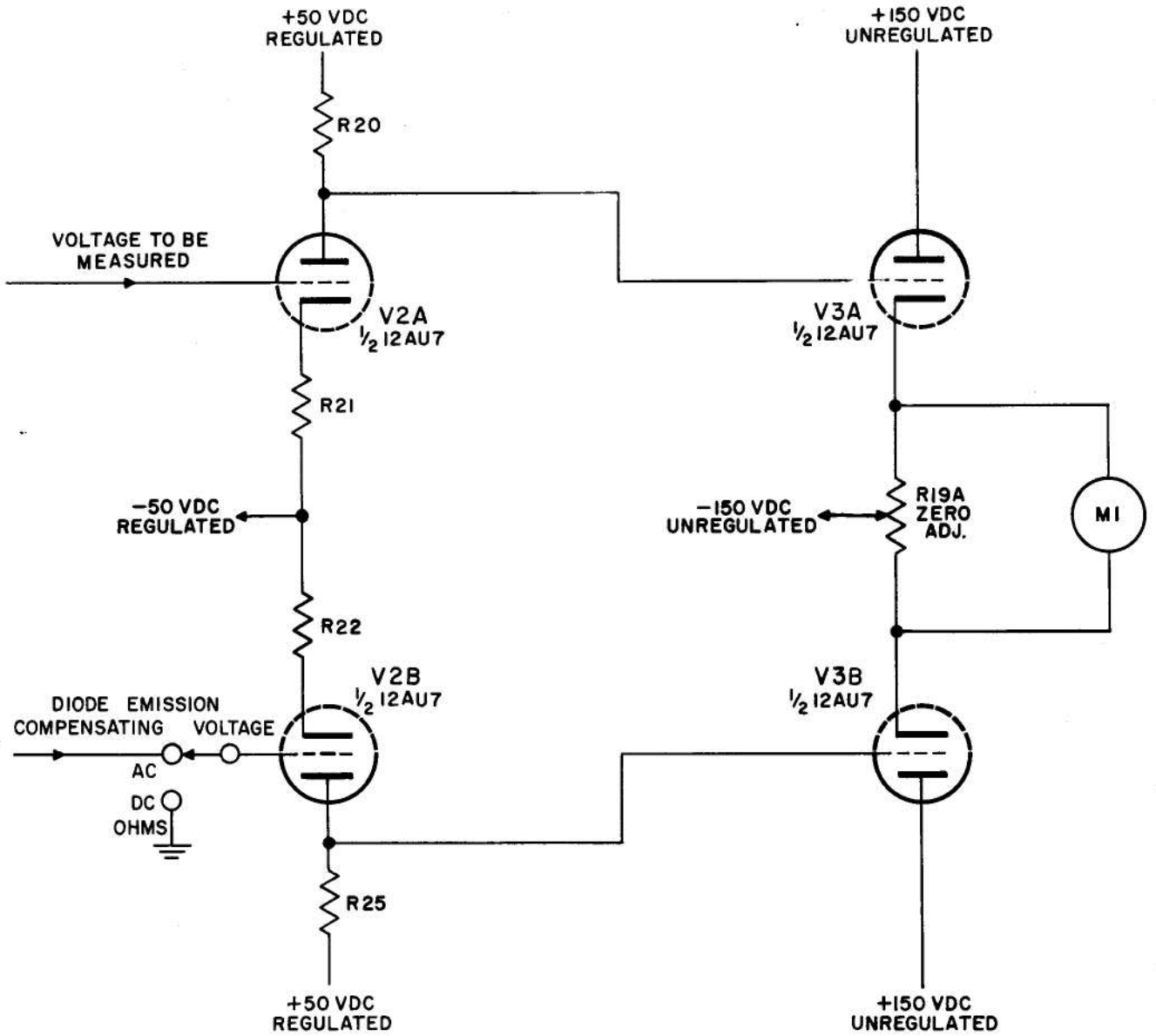

Figure 3-5. Basic DC Amplifier Circuit

To permit measurement of either positive or negative d-c voltages without reversal of the test leads the SELECTOR switch reverses the meter within the bridge so that an up-scale reading is obtained with either polarity.

For a-c measurements the range switch of the voltmeter connects in series with the meter additional current-reducing resistors (R35 through R40) to reduce the meter current by approximately 30% so that the same meter scale can be used for the a-c

and d-c ranges. For the one and three volt a-c ranges, however, it is necessary to use special meter scales because the probe diode operation at low voltages is non-linear.

For resistance measurements the SELECTOR switch connects the meter in series with the front panel OHMS ADJ. ∞ control which adjusts the sensitivity of the meter to obtain a precise full-scale indication before making a measurement.

3-6 RESISTANCE MEASUREMENT

When the multimeter is to be used to measure resistance, the range switch connects an additional set of precision resistors to the input of the d-c amplifier as shown in the block diagram in Figure 3-1. A small, stable voltage of about 1.2 volts is taken from the regulated power supply and applied through a precision resistance to the input of the d-c amplifier thereby causing full-scale deflection of the meter. The resistance to be measured is then connected between the input of the d-c amplifier and ground. This resistance thus completes a voltage divider and reduces the voltage applied to the amplifier, bringing the meter reading down-scale. The range switch of the multimeter connects appropriate values of precision resistors into the ohmmeter circuit to extend the resistance-measuring range. (On the RX1 range the necessary voltage comes from a small selenium rectifier which is not regulated.)

3-7 POWER SUPPLY

The power supply circuit includes a full-wave rectifier with an RC filter at the output of the rectifier. An OB2 105-volt regulator tube provides regulated d-c

voltage for operation of the differential d-c amplifier, ohmmeter circuits, and diode compensating circuits. D-c power for operating the bridge is obtained directly from the rectified output of the power supply. A regulated heater voltage of 5 volts a-c is also provided for the probe diode, regulation being obtained through the use of the constant current ballast tube V6. Potentiometer R50 shunting the diode heater is used to adjust the voltage across the heater to 5 volts. A small resistor is connected in series with the heater of V2 to operate this heater on approximately 4-1/2 volts. The heater winding also supplies a voltage which is rectified by a metallic rectifier for the RX1 resistance OHMS range only. This voltage is adjusted to approximately 1.2 volt by R49 to obtain full-scale deflection on the RX1 range consistent with that on the RX10 range, when the line voltage is at 115 volts.

The power transformer for the multimeter is equipped with two primary windings so that the instrument may be connected for operation on either 115 or 230 volt power. The windings are connected in parallel for use with 115 volts, and in series for 230 volts. For proper phasing of the windings the terminals on the transformer are numbered and wired as shown on the schematic diagram for the multimeter.

SECTION IV MAINTENANCE

4-1 INTRODUCTORY

No routine maintenance procedures are required for the ϕ Model 410B. When replacing any of the tubes in the equipment, however, it is desirable to check the accuracy of the multimeter. To do this it is necessary to have a precision d-c voltmeter and a precision a-c voltmeter, preferably of the dynamometer type. The accuracy of these instruments should be within 1-2%, because the basic accuracy of the 410B is within 3%. The procedure to follow in checking and adjusting the calibration of the instrument are described in paragraphs 4-4 and 4-5.

If a tube failure occurs after an extended period of use such as 1000 hours of operating time, it is desirable to replace all tubes at that time, to avoid need for more frequent recalibration than necessary.

A trouble-shooting chart listing possible operating troubles is included at the end of this section (paragraph 4-7).

4-2 TUBE REPLACEMENT

REPLACING V1 -

When replacing probe diode V1, some change in a-c voltage-measuring accuracy may occur on the lower three a-c measuring ranges of the instrument. In a typical case these changes will be less than 2%. With some diodes the changes can be greater than this, however, so it is desirable to recheck calibration accuracy.

The quality of the individual replacement diode will also effect the high frequency accuracy of the instrument. However, specialized equipment is necessary for checking the high frequency accuracy. If high frequency errors are suspected with a new diode installed, it is recommended that another replacement diode be tried.

The heater voltage should be checked when probe diode V1 is replaced. Accurate setting of this voltage is necessary to insure proper operation and maximum

life of the probe diode. To check the heater voltage of probe diode V1:

- 1) Remove back cover from the instrument by pushing down the button at the top rear of cabinet and slide the back cover off.
- 2) Remove two retaining screws from instrument rear and slide instrument chassis forward out of cabinet.
- 3) Connect 410B to variable power transformer, set line voltage to 115 volts (or 230 volts) and turn 410B on.
- 4) Connect an ac voltmeter such as ϕ Model 400D/H/L or Model 403A, between pin 7 of V6 (ballast tube) and chassis ground. If necessary, adjust R50 to obtain 5.0 volts rms.

REPLACEMENT OF V2 AND V3 -

When V2 or V3 are replaced, five checks should be made:

1. Amplifier balance with line voltage at 115 volts.
2. Microphonics: stability of the zero adjustment when the tubes are jarred.
3. Amplifier balance with line voltage change from 103 to 127 volts.
4. Gas in V2.
5. Voltage calibration.

NOTE

The following instructions describe a procedure which will provide optimum instrument performance over a wide range of line voltages. It is based on the procedure used at the factory. If such performance is not needed, the care in selection of tubes can be reduced considerably.

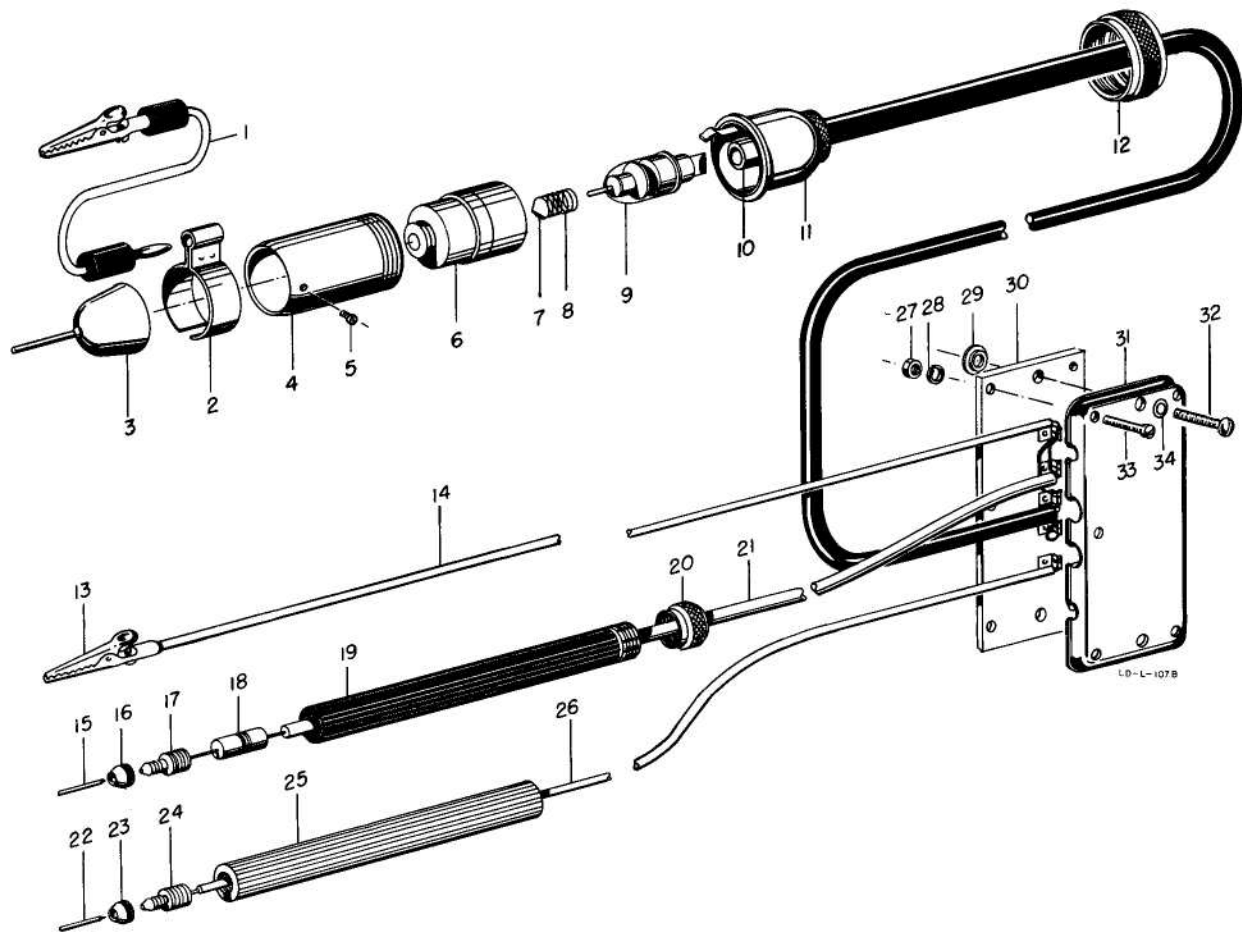

Figure 4-1. Test Probe Assembly, Including Exploded View of AC Probe

The following steps should be performed in the order given. If a tube fails to pass any test, it must be replaced and all tests repeated again in the proper order.

To obtain maximum range of adjustment of the ZERO SET control it is necessary that the four triode sections of the two 12AU7 tubes be similar in plate current characteristics. It is possible to have a combination of tubes which will have very little zero adjustment range on, say, (+) DC VOLTS and an excessive amount on (-) DC VOLTS. This is caused by non-uniformity between tubes. These characteristics also change considerably in the first 50 hours of tube operation.

A suggested method for determining if individual tubes are reasonably balanced is to first remove

V2. With V3 only in its socket, check the ZERO ADJUST range on both (+) DC and (-) DC. Ideally, it should be the same in both positions of the FUNCTION switch. Select several tubes which are as nearly balanced as possible, by trying them in the V3 socket. Use the tube which has the best balance for V2 and the next best for V3. To insure the best margin of zero adjustment, the tubes should be selected to allow the ZERO ADJUST control to move the meter pointer at least 1/3 of the way up scale both with (+) and (-) DC VOLTS positions of the FUNCTION switch, when both tubes are in their sockets. Next, check for microphonics by first accurately setting the ZERO ADJUST to zero the meter and then tap V2 and V3. If the meter zero irrationally changes position, one or both of the tubes have loose elements, which allow the static plate current to change value when jarred. Generally,

V2 is the most sensitive and should be suspected first. If the elements in V3 are very loose, it will cause the same indication. The defective tube or tubes should be replaced with ones which are of more sound construction. The balance test must be again repeated as described above.

To insure that the cathode emission is ample, the line voltage should be set to 115 volts. Allow the instrument to heat run for at least 5 minutes. Zero set the meter. Reduce the line voltage to 103 volts for a period of at least 1 minute. If the tubes have good cathode emission characteristics, the meter zero will not drift more than approximately 5%. If the zero drifts down scale to the left, the amount of drift can be measured from changing the position of the FUNCTION switch to the opposite polarity: (+) to (-) or vice versa, depending on the original position, so an up scale reading is obtained.

If the drift is not excessive, return the line voltage to 115 volts and reset the meter zero. After the tubes have stabilized at 115 volts, raise the line voltage to 127 volts and repeat the drift check. Again the drift should be less than 5%. If not, try another tube or tubes. V2 should be replaced first and then V3. All previous steps should be repeated first.

To check for a gassy V2, first accurately zero set the meter. Check the accuracy of the setting by switching the FUNCTION switch from (+) to (-) and back. If the setting is perfect, the meter pointer will not move. Feed in a d-c voltage of exactly 1.0 volt. (To facilitate this test the voltage should be fed through a dpdt switch so that the polarity can be quickly switched. If this is not done, it is very difficult to determine by eye if the two readings are the same within 1%).

If V2 is gassy, a certain error exists on the 1 volt range due to the gas current flowing through the 100 megohm resistive divider. Since the basic amplifier gain is set with the FUNCTION switch set to (+), this error is compensated for when the gain is set. When the polarity is reversed, however, the grid is biased negatively by the measured voltage and the value of the gas current changes somewhat. This results in a different reading.

A second method of checking for gas current is, to first accurately set the meter zero as described above. The RANGE SWITCH should be on the 1 VOLT DC range. Rotate the RANGE SWITCH to 300 VOLTS. If the input tube V2 is gassy, the zero will shift when the RANGE SWITCH is rotated. The grid impedance to ground is 100 megohms on the 1 VOLT range and approximately 300,000 ohms, on the 300 volt range (neglecting a fixed 5.6 megohm resistor). The effects of the gas current are thus reduced as the RANGE SWITCH is advanced to a higher range, which in turn

causes the meter zero setting to change. **NOTE:** The effects of this test should not be confused with those of microphonic tubes. The Microphonic tube test must have been passed first.

Final voltage calibration should be made after tubes have been installed which pass all the above checks. Since the gain characteristics change somewhat during the first fifty hours of operation, it is desirable to heat run the instrument for at least this long before a final calibration is made. The calibration procedure to be followed after replacement of V2 or V3 is described in paragraph 4-4.

4-3 REPLACEMENT OF BALLAST TUBE V6

Failure of V6 is usually caused by overloading due to shorts. For this reason, before installing a new ballast tube, it is recommended that the resistance between pin 7 of V6 and ground be checked with V6 removed from socket. The resistance will initially read 2 to 3 ohms and slowly increase. If the reading does not increase to above 4 ohms, there may be a short. If the resistance increases to over 4 ohms, it is ordinarily safe to install the new ballast tube.

After installing the new ballast tube, measure the heater voltage of probe diode V1 (see para. 4-2).

4-4 BASIC VOLTAGE CALIBRATION

Before attempting to adjust either the a-c calibration accuracy or the ohmmeter calibration accuracy, it is necessary that the calibration of the d-c measuring circuits be accurate. Checking the d-c calibration accuracy is also recommended after replacing V2 or V3. The procedure is as follows:

- a. Connect multimeter to a 115-volt power source and allow to heat for at least 15 minutes. It is desirable that the line voltage be accurately adjusted to 115 volts or to the predominating line voltage value if that value is somewhat less or more than 115 volts. The power transformer in the equipment is also designed to accommodate 230 volt lines; if the equipment is operated from 230 volt lines, the above information should be modified accordingly.
- b. Remove the back cover from the instrument. To remove the cover push down the button at the top rear of the cabinet and slide back cover off.

c. Zero set the instrument with the RANGE switch set to the 1 volt range and the SELECTOR switch set to the + and - positions as described in paragraph 2-5.

d. Set SELECTOR switch to +. Range switch should remain at 1 volt.

e. Apply exactly 1 volt d-c to the d-c test leads. This 1 volt value can be obtained using a battery and potentiometer arrangement. The voltage applied to the voltmeter should be monitored and adjusted using the precision d-c meter described earlier. With exactly 1 volt applied to the multi-meter the meter pointer should indicate an exact full-scale reading on the uppermost scale. If necessary, adjust R32 through the back of the instrument to make the meter read exactly full-scale. R32 is identified in Figure 4-2 and by appropriate markings on the back of the instrument.

f. The calibration of the remaining d-c ranges should now be checked insofar as the external precision meter and d-c source will permit. No adjustment circuits are provided, however, for the remaining d-c ranges. The accuracy of these ranges is determined by the values of the precision range switch resistors R3 through R9. A gross inaccuracy in any of the remaining d-c ranges indicates an incorrect range resistor or resistors.

g. Check a-c calibration accuracy as described below.

4.5 AC VOLTAGE CALIBRATION

The accuracy of the a-c voltage ranges of the multi-meter should be checked after the probe diode V1 has been replaced. Before checking the a-c ranges, it is desirable to adjust the basic d-c voltage calibration as described above in paragraph 4-4. The procedure for checking and adjusting the a-c calibration is as follows:

a. Adjust line voltage as described in step a. of paragraph 4-4 above; remove back cover as described in step b. of the same paragraph.

b. Set SELECTOR switch to a-c and RANGE switch to 1 volt position. Allow equipment to heat for at least 15 minutes with these switch settings.

c. Set the FUNCTION switch to (+) DC and set the meter zero. Check by switching from (+) to (-) and back. There should be no shift. Set the FUNCTION switch to AC. Zero set a-c circuit with the AC ZERO control. (The RANGE switch still at the 1 volt position.)

d. Apply to the a-c probe a voltage of exactly 1 volt rms. This voltage should have an accurate, undistorted sine waveform. The frequency of this voltage should preferably be 100 cps or higher if permitted by the frequency characteristic of the dynamometer voltmeter. A good voltage source for this purpose is an accurate audio oscillator such as the Model 200AB, 205AG, etc. To determine that the voltage applied to the probe is accurate, it should be monitored by the precision dynamometer type voltmeter.

e. With exactly 1 volt rms applied to the probe, the voltmeter should indicate exactly full-scale on the 1 volt a-c (red) meter scale. If not, adjust R35 (available through back of instrument).

f. Set the RANGE selector to the 3-volt range. Increase voltage applied to probe to exactly 3 volts rms. Adjust potentiometer R39 to obtain accurate full-scale reading on the 3 volt a-c (red) meter scale.

g. Calibrate the remaining a-c ranges, reading the 1 and 3 volt d-c (black) scales of the meter. The following chart shows the adjusting potentiometers for each of the a-c ranges.

RANGE Switch Setting	Calibrating Voltage	Adjustment Resistor
1V	1V RMS	R35
3V	3V RMS	R39
10V	10V RMS	R40
30V	30V RMS	R36
100V	100V RMS	R37
300V	300V RMS	R38

4.6 OHMMETER ADJUSTMENTS

No internal adjustments are provided for the ohmmeter circuits other than for the full-scale setting of the RX1 range. The full-scale setting of the RX1 range may begin to differ from that of the other ranges as selenium rectifier CR1 ages. (Assuming the line voltage is the same value as when R49 was originally set.) To adjust the full-scale setting of the RX1 range to be equal to the full-scale setting of the other ranges, proceed as follows:

a. Connect multimeter to power line and allow to warm up. Normally the multimeter should be operated from 115 volts; however, if it is to be operated at line voltages substantially higher or lower than 115 volts the adjustment may be made at the expected line voltage.

- b. Zero set the instrument as described in paragraph 2-3.
- c. Set RANGE switch to RX10 range and adjust OHM ADJ. ∞ for exact full-scale meter reading.
- d. Set RANGE switch to RX1 range.
- e. If meter pointer does not read exactly full-scale (∞), remove back panel from multimeter case and adjust R49 as necessary.

The accuracy of the RX1 range is not affected if the full-scale (∞) is not the same for RX1 and RX10 and above, since the OHMS ADJ. ∞ control should be adjusted to bring the pointer to (∞) before measurements are made.

4-7 TROUBLE SHOOTING CHART

Table 4-1. Trouble Shooting Chart

SYMPTOM	CAUSE OF TROUBLE	REMEDY AND CHECKS
AC power cord plugged in, instrument turned on, pilot light does not light and no readings obtained.	Defective power cord, plug, or receptacle. Fuse (F1) blown. Defective a-c Switch.	Check power source and connections. Check fuse (F1) and rectifier tube V5. Check power switch continuity.
No readings obtainable, no zero adjustment, pilot lamp lights.	Defective tubes V2, V3 or V5.	Check V2, V3, and V5, if necessary, replace and recalibrate, see paragraph 4-2.
Zero set drift or zero set not possible.	Defective tubes V2 and V3.	Check tubes V2 and V3, replace and recalibrate, see paragraph 4-2.
No a-c readings, d-c readings normal.	Probe cap loose, defective V1 or V6.	Tighten probe cap. Check V1 for operation.
A-c zero set drifts or inaccurate a-c readings only on all ranges.	Defective V1.	Replace V1 and recalibrate as instructed in paragraph 4-3.
A-c zero set not possible.	Outside shield of a-c probe cable shorted to ground.	Check cable and repair short.
Inaccurate d-c and a-c readings.	Defective V2 or V3, defective range resistor (R3 through R9), misadjustment of R32.	Check V2 and V3 or R3 through R9, readjust R32 as instructed in paragraph 4-4.
Erroneous resistance readings following use of OHMS probe on high d-c voltage.	Burned resistors R10 through R13.	Check resistors R10 through R13 and if necessary, replace burned resistor.

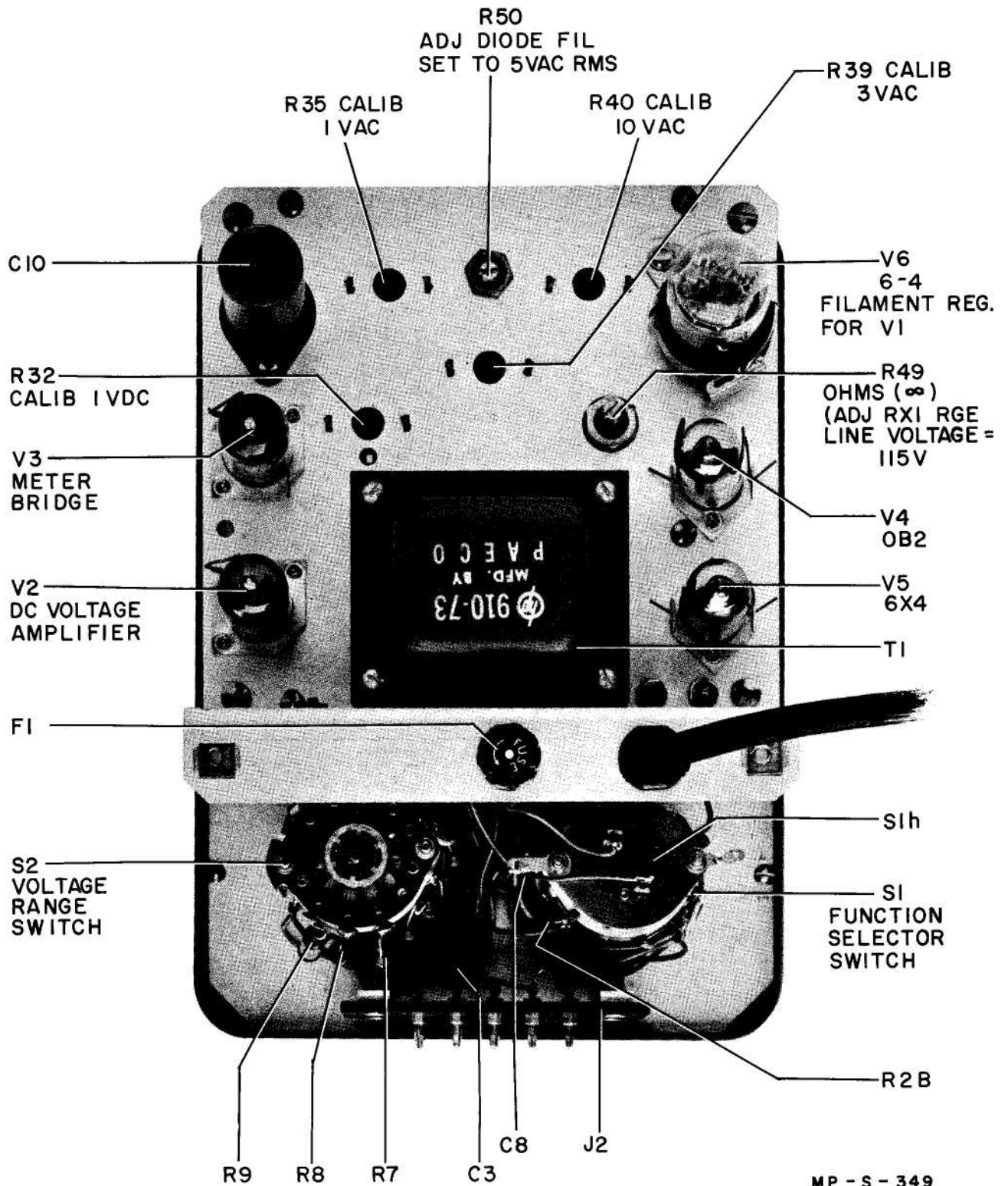

Figure 4-2. Rear View of Model 410B Chassis Removed from Instrument Case

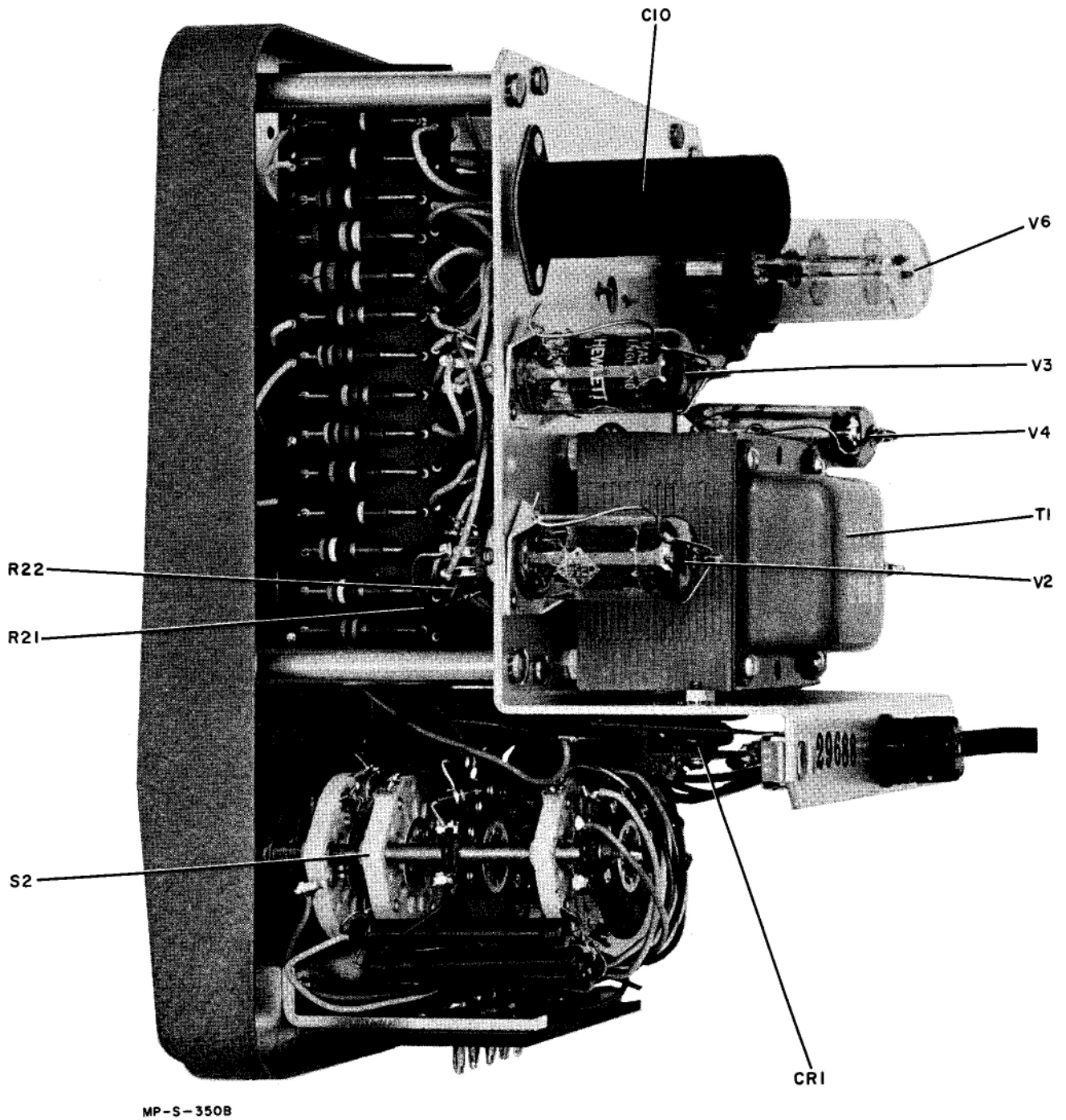

Figure 4-3. Right Side View of Model 410B

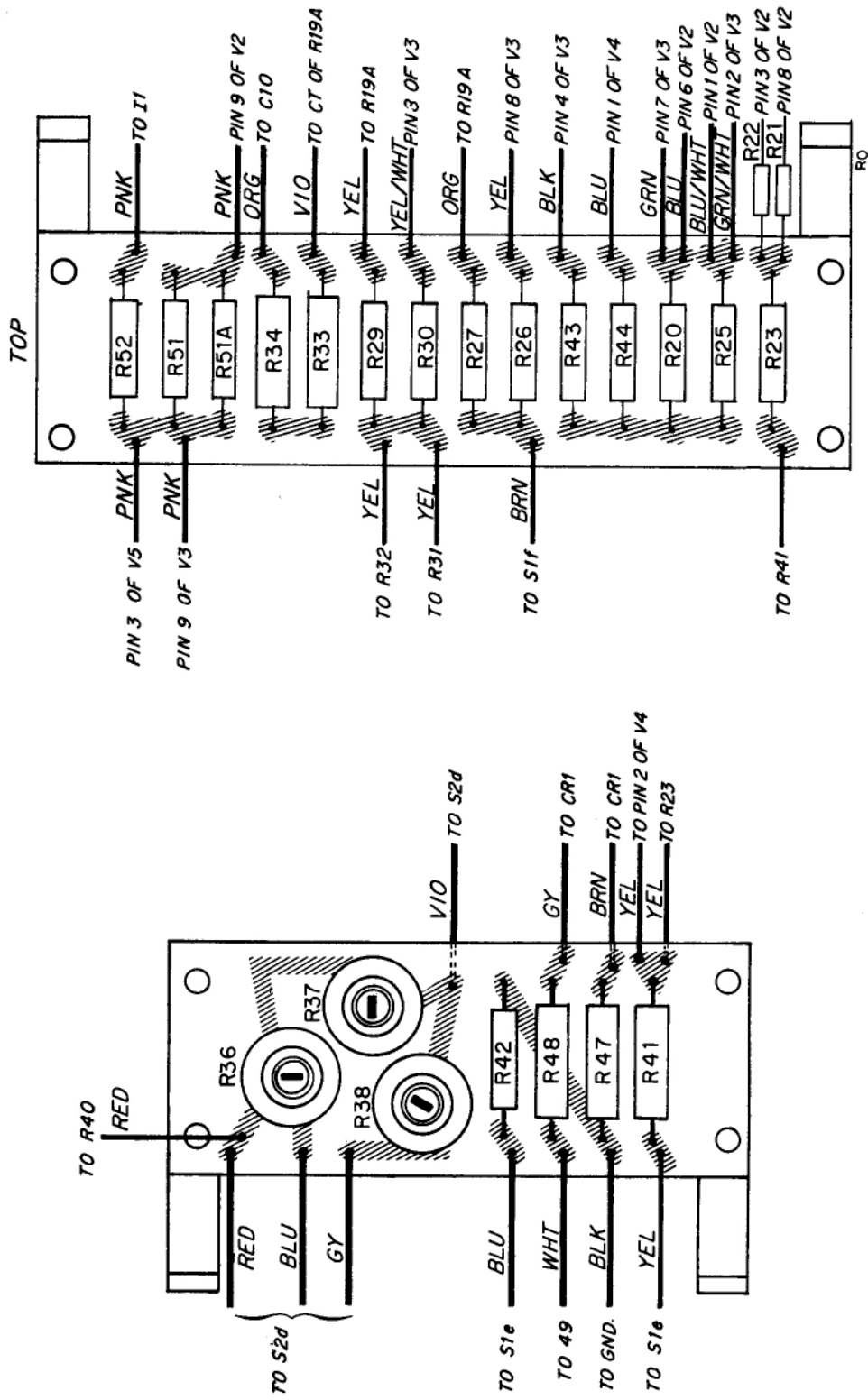

Figure 4-5. Resistor Board Details Model 410B

- NOTES:
1. ALL CIRCUIT REFERENCES CORRESPOND TO THOSE IN THE SCHEMATIC WIRING DIAGRAM.
 2. FRONT AND REAR SECTIONS OF SWITCH ARE VIEWED FROM THE BOTTOM OF THE INSTRUMENT AND THE KNOB END OF THE SWITCH. SWITCH SHOWN IN THE IV POSITION.

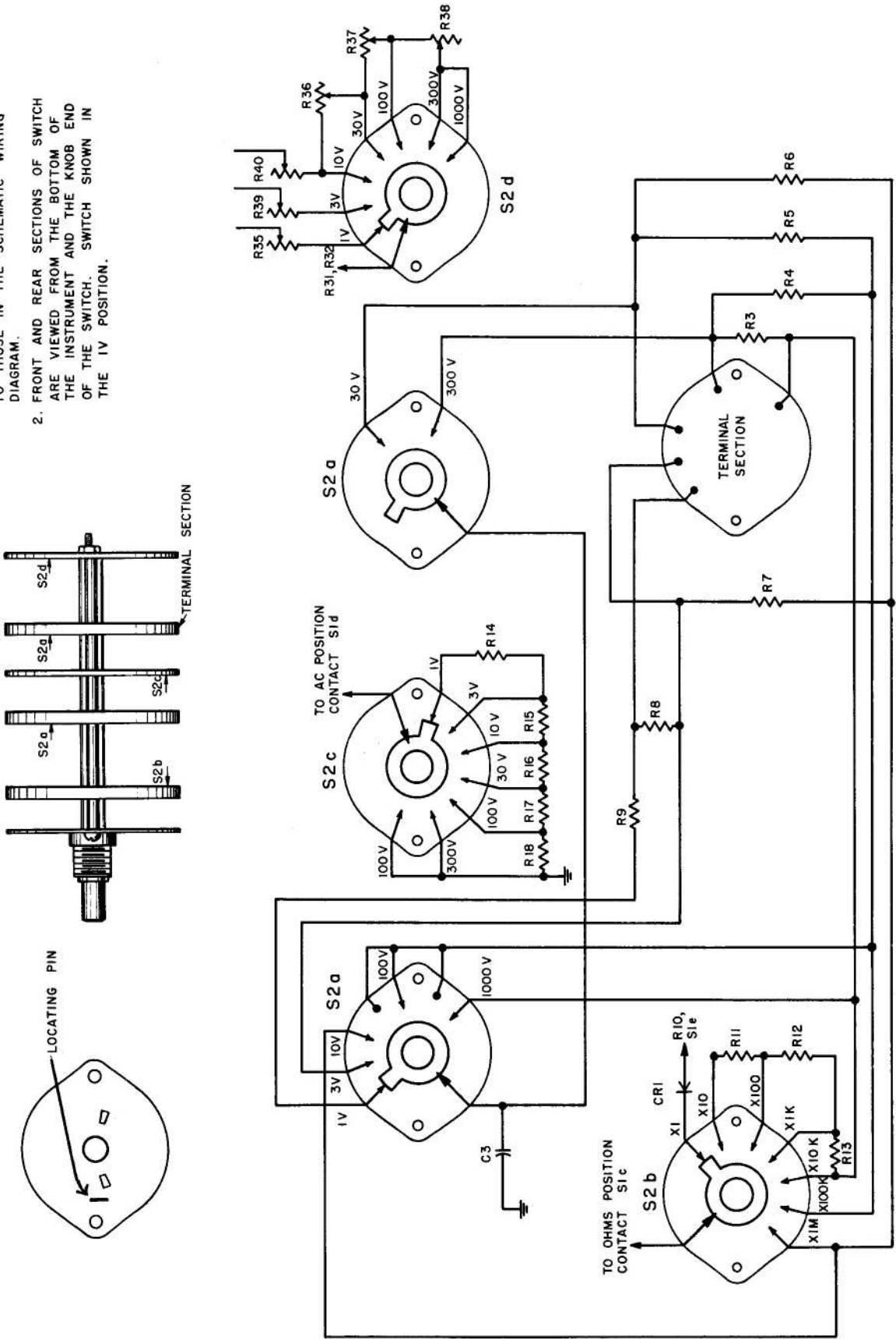
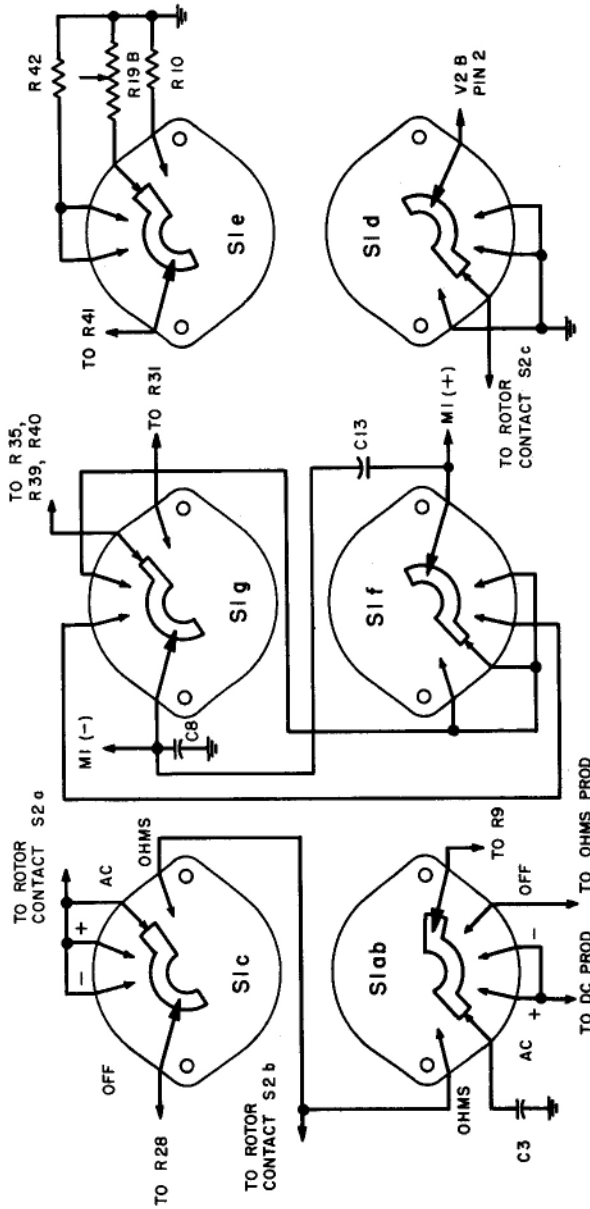
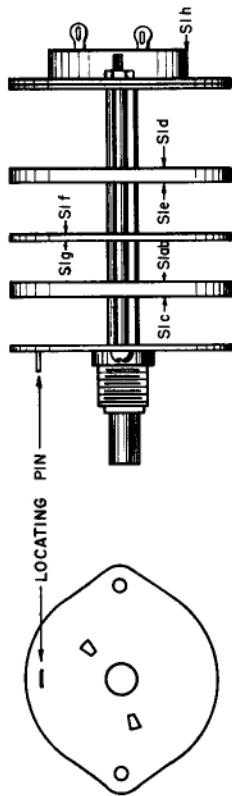

Figure 4-6. Range Switch Details Model 410B

- NOTES:
1. ALL CIRCUIT REFERENCES CORRESPOND TO THOSE IN THE SCHEMATIC WIRING DIAGRAM.
 2. FRONT AND REAR SECTIONS OF SWITCH ARE VIEWED FROM THE BOTTOM OF THE INSTRUMENT AND THE KNOB END OF THE SWITCH. SWITCH SHOWN IN THE AC POSITION.



MODEL 410 B
SELECTOR SWITCH DETAILS

Figure 4-7. Selector Switch Details Model 410B

SECTION V TABLE OF REPLACEABLE PARTS

NOTE

Standard components have been used in this instrument, whenever possible. Special components may be obtained from your local Hewlett-Packard representative or from the factory.

When ordering parts always include:

1.  Stock Number.
2. Complete description of part including circuit reference.
3. Model number and serial number of instrument.
4. If part is not listed, give complete description, function and location of part.

Corrections to the Table of Replaceable Parts are listed on an Instruction Manual Change sheet at the front of this manual.

RECOMMENDED SPARE PARTS LIST

Column RS in the Table lists the recommended spare parts quantities to maintain one instrument for one year of isolated service. Order complete spare parts kits from the Factory Parts Sales Department. ALWAYS MENTION THE MODEL AND SERIAL NUMBERS OF INSTRUMENTS INVOLVED.

TABLE OF REPLACEABLE PARTS

CIRCUIT REF.	DESCRIPTION, MFR. * & MFR. DESIGNATION	Ⓢ STOCK NO.	TQ	RS		
C1, 2	Capacitors: part of AC probe					
C3	Capacitor: fixed, mica 4700 pf Z*	0140-0017	1	1		
C4 thru C9	Capacitor: fixed, ceramic .005 μ f, 500 vdcw K*	0150-0014	6	2		
C10	Capacitor: fixed, electrolytic, 4 μ f, 450 vdcw CC*	0180-0055	1	1		
CR1	Rectifier, metallic Federal Tel & Radio	1880-0005	1	1		
F1	Fuse, cartridge: 0.6 amp, slow blow, for 115V operation T*	2110-0016	1	10		
	Fuse, cartridge: 1/4 amp, slow blow, for 230V operation E*	2110-0018				
I1	Lamp, incandescent: 6-8V .15 amp, #47 N*	2140-0009	1	1		
M1	Meter HP*	1120-0009	1	1		
P1	Power cord Elec. Cords Co.	8120-0050	1	1		
R1	Resistor: fixed, composition, 22 megohms, $\pm 10\%$, 1 W B* part of Cable Assembly, DC probe	0690-2261	2	1		
R2	Same as R1 (part of AC probe)					
R3	Resistor: fixed, deposited carbon, 216,300 ohms, $\pm 1\%$, 1 W HP*	0730-0079	1	1		
R4	Resistor: fixed, deposited carbon 683,700 ohms, $\pm 1\%$, 1 W HP*	0730-0096	1	1		
R5	Resistor: fixed deposited carbon, 2.163 megohms, $\pm 1\%$, 1 W HP*	0730-0113	1	1		
R6	Resistor: fixed, deposited carbon, 6.837 megohms, $\pm 1\%$, 1 W HP*	0730-0130	1	1		

* See "List of Manufacturers Code Letters For Replaceable Parts Table".

TQ - Total quantity used in the instrument.

RS - Recommended spares for one year isolated service for one instrument.

TABLE OF REPLACEABLE PARTS

CIRCUIT REF.	DESCRIPTION, MFR. * & MFR. DESIGNATION	Ⓢ STOCK NO.	TQ	RS		
R7, 8	Resistor: fixed, deposited carbon 21.63 megohms, $\pm 1\%$, 2 W HP*	0733-0005	2	1		
R9	Resistor: fixed, deposited carbon, 46.74 megohms, $\pm 1\%$, 2 W HP*	0733-0011	1	1		
R10	Resistor: fixed, deposited carbon, 100 ohms, $\pm 1\%$, 1/2 W NN*	0727-0043	1	1		
R11	Resistor: fixed, deposited carbon, 900 ohms, $\pm 1\%$, 1/2 W NN*	0727-0095	1	1		
R12	Resistor: fixed, deposited carbon, 9000 ohms, $\pm 1\%$, 1/2 W NN*	0727-0152	1	1		
R13	Resistor: fixed, deposited carbon, 90,000 ohms, $\pm 1\%$, 1/2 W NN*	0727-0203	1	1		
R14	Resistor: fixed, deposited carbon, 683,700 ohms, $\pm 1\%$, 1/2 W HP*	0727-0251	1	1		
R15	Resistor: fixed, deposited carbon, 216,300 ohms, $\pm 1\%$, 1/2 W HP*	0727-0223	1	1		
R16	Resistor: fixed, composition, 68,000 ohms, $\pm 10\%$, 1/2 W B*	0687-6831	1	1		
R17	Resistor: fixed, composition, 22,000 ohms, $\pm 10\%$, 1/2 W B*	0687-2231	1	1		
R18	Resistor: fixed, composition, 10,000 ohms, $\pm 10\%$, 1/2 W B*	0687-1031	1	1		
R19 A,B	Resistor: variable, wirewound, 2 sections, front: 100 ohms, rear: 200 ohms $\pm 10\%$, 2W BO*	2100-0050	1	1		
R20	Resistor: fixed, composition, 3.9 megohms, $\pm 5\%$, 1 W B*	0689-3955	2	1		
R21, 22	Resistor: fixed, deposited carbon, 500,000 ohms, $\pm 1\%$, 1/2 W NN*	0727-0244	2	1		
R23	Resistor: fixed, composition, 13 megohms, $\pm 5\%$, 1 W B*	0689-1365	1	1		
R24	This circuit reference not assigned					

* See "List of Manufacturers Code Letters For Replaceable Parts Table".

TQ - Total quantity used in the instrument.

RS - Recommended spares for one year isolated service for one instrument.

TABLE OF REPLACEABLE PARTS

CIRCUIT REF.	DESCRIPTION, MFR. * & MFR. DESIGNATION	Ⓢ STOCK NO.	TQ	RS		
R25	Same as R20					
R26	Resistor: fixed, composition, 680 ohms, $\pm 5\%$, 1 W B*	0689-6815	2	1		
R27	Resistor: fixed, composition, 270 ohms, $\pm 5\%$, 1 W B*	0689-2715	2	1		
R28	Resistor: fixed, composition, 5.6 megohms, $\pm 10\%$, 1/2 W B*	0687-5651	1	1		
R29	Same as R27					
R30	Same as R26					
R31	Resistor: variable, composition, linear taper, 1000 ohms $\pm 20\%$, 1/2 W G*	2100-0036	1	1		
R32	Resistor: variable, composition, linear taper, 500 ohms $\pm 30\%$, 1/4 W BO*	2100-0185	4	1		
R33	Resistor: fixed, composition, 6800 ohms, $\pm 10\%$, 2 W B*	0693-6821	1	1		
R34	Resistor: fixed, composition, 10,000 ohms, $\pm 10\%$, 2 W B*	0693-1031	1	1		
R35	Same as R32					
R36, 37, 38	Resistor: variable, wirewound, 50 ohms, $\pm 10\%$, 1 W Mel-Rain Corp.	2100-0206	3	1		
R39, 40	Same as R32					
R41	Resistor: fixed, composition, 4700 ohms, $\pm 10\%$, 2W B*	0693-4721	1	1		
R42	Resistor: fixed, composition, 100 ohms, $\pm 10\%$, 1W B*	0690-1011	1	1		
R43	Resistor: fixed, composition, 2700 ohms, $\pm 10\%$, 1W B*	0690-2721	1	1		
R44	Resistor: fixed, composition, 2200 ohms, $\pm 10\%$, 1W B*	0690-2221	1	1		
R45, 46	Resistor: fixed, wirewound, 5000 ohms, $\pm 10\%$, 10W S*	0816-0006	2	1		

* See "List of Manufacturers Code Letters For Replaceable Parts Table".

TQ - Total quantity used in the instrument.

RS - Recommended spares for one year isolated service for one instrument.

TABLE OF REPLACEABLE PARTS

CIRCUIT REF.	DESCRIPTION, MFR. * & MFR. DESIGNATION	Ⓢ STOCK NO.	TQ	RS		
R47	Resistor: fixed, wirewound, 12 ohms HP*	410B-26	1	1		
R48	Resistor: fixed, composition, 33 ohms, ±10%, 2W B*	0693-3301	1	1		
R49, 50	Resistor: variable, wirewound, 25 ohms, ±10%, 3W Precision Parts Co.	2100-0035	2	1		
R51	Resistor: fixed, composition, 10 ohms ±10%, 1 W Optimum value selected at factory Average value shown B*	0690-1001	1	1		
R51A	Resistor: fixed, composition, 18 ohms ±10%, 1 W B*	0690-1801	1	1		
R52	Resistor: fixed, composition, 33 ohms, ±10%, 1W B*	0690-3301	1	1		
R53	Resistor: fixed, composition 330 ohms, ±10%, 1W B*	0690-3311	1	1		
S1A thru S1G	Selector Switch Assembly Switch, rotary: less components HP* W*	410B-19A 3100-0065	1 1	1		
S1H	Switch, power: rear section of selector switch W*	3130-0030				
S2	Range Switch Assembly HP*	410B-19W	1	1		
T1	Transformer, power HP*	9100-0021	1	1		
V1	Tube, electron: 2-01C or Tube, electron: EA53 HP*	1920-0008 1920-0010	1	1		
V2, 3	Tube, electron: 12AU7 HP* Tubes selected for best performance will be supplied by Ⓢ(if ordered by ⓈStock No.), but tubes meeting EIA standards will normally result in the instrument operating within speci- fications.	G-73R	2	2		
V4	Tube, electron: OB2 ZZ*	1940-0007	1	1		
V5	Tube, electron: 6X4 ZZ*	1930-0016	1	1		
V6	Tube, ballast: #6-4 C*	0852-0003	1	1		

* See "List of Manufacturers Code Letters For Replaceable Parts Table".

TQ- Total quantity used in the instrument.

RS- Recommended spares for one year isolated service for one instrument.

TABLE OF REPLACEABLE PARTS

CIRCUIT REF.	DESCRIPTION, MFR. * & MFR. DESIGNATION	hp STOCK NO.	TQ	RS		
	MISCELLANEOUS					
	Connector board: male	HP* 410B-76M	1	1		
	Holder, fuse:	T* 1400-0007	1	1		
	Pilot lamp jewel	II* 1450-0003	1	1		
	Knob: engraved AC	HP* G-74AC	1	1		
	Knob: SELECTOR, RANGE	HP* G-74N	2	1		
	Knob: ZERO ADJ.	HP* G-74J	1	1		
	Knob: OHMS ADJ.	HP* G-74C	1	1		
	The numbers shown in the circuit reference column identify the following parts on the Complete Probe Assembly drawing.					
	Assembly, Test lead, includes AC probe (less diode) DC probe, Ohms probe, Common Lead, female connector board and shield	HP* 410B-21-95A				
	Assembly, AC probe (less diode) with cable	HP* 410B-21-95B				
	Assembly, DC probe with cable	HP* 410B-21-95C				
	Assembly, Ohms probe with cable	HP* 410B-21-95D				
	Assembly, Common Lead	HP* 410B-21-95E				
	NOTE: The numbers shown in the circuit reference column identify the following parts shown in Figure 4-1.					
1	Jumper, ground, for AC probe	HP* 410B-21J				
2	Clip, ground, for AC probe	HP* 410B-21H				
3	Probe head	HP* 410B-21D				
4	Sleeve, for AC probe	HP* 410B-21E				

* See "List of Manufacturers Code Letters For Replaceable Parts Table".

TQ - Total quantity used in the instrument.

RS - Recommended spares for one year isolated service for one instrument.

TABLE OF REPLACEABLE PARTS

CIRCUIT REF.	DESCRIPTION, MFR. * & MFR. DESIGNATION	HP STOCK NO.	TQ	RS		
5	Screw, Machine, Fillister Head, No. 4-40 x 3/16 in.	HP* 2220-0001				
6	Assembly, probe contact, for AC Probe	HP* 410B-21C				
7, 8	Tip and contact spring (for 2-01C diode) (for EA53 diode)	HP* 410B-21N HP* 410B-21P				
9	Tube, electron (see V1)					
10, 11	Assembly, socket, for probe diode	HP* 410B-21B				
12	Ring, retaining	410B-21F				
13	Clip, alligator	HP* 1400-0046				
14	Cable, black, 48 in.	HP* 8160-0001				
15	Needle, phono	HP* 1490-0013				
16, 17, 19	Body, DC probe	HP* 410B-21L				
18	Resistor: fixed, composition, (see R1)					
20	Nut	HP* 410B-21K				
21	Cable, coaxial, 48 in.	HP* 8120-0003				
22	Same as 15					
23, 24, 25	Body, Ohms probe	HP* 1490-0011				
26	Cable, red, 48 in.	HP* 8160-0002				
27	Nut, No. 4-40 x 3/16 in.	HP* 2340-0001				
28	Washer, lock, No. 4, 1/16 in.	HP* 2190-				
29	Washer, fiber, extruded	HP* 3050-0005				
30	Connector, female board	HP* 410B-76F				
31	Shield, test lead terminal board	HP* 410B-55				
32	Screw, Machine, Round head, No. 6-32 x 1-1/8 in.	HP* 2360-0015				
33	Screw, Machine, Fillister Head, No. 4-40 x 3/4 in.	HP* 2220-0006				
34	Washer, flat, steel, No. 6	HP* 3050-0016				

* See "List of Manufacturers Code Letters For Replaceable Parts Table".

TQ - Total quantity used in the instrument.

RS - Recommended spares for one year isolated service for one instrument.

LIST OF CODE LETTERS USED IN TABLE OF REPLACEABLE PARTS TO DESIGNATE THE MANUFACTURERS

<u>CODE LETTER</u>	<u>MANUFACTURER</u>	<u>ADDRESS</u>	<u>CODE LETTER</u>	<u>MANUFACTURER</u>	<u>ADDRESS</u>
A	Aerovox Corp.	New Bedford, Mass.	AK	Hammerlund Mfg. Co., Inc.	New York 1, N. Y.
B	Allen-Bradley Co.	Milwaukee 4, Wis.	AL	Industrial Condenser Corp.	Chicago 18, Ill.
C	Amperite Co.	New York, N. Y.	AM	Insuline Corp. of America	Manchester, N. H.
D	Arrow, Hart & Hegeman	Hartford, Conn.	AN	Jennings Radio Mfg. Corp.	San Jose, Calif.
E	Bussman Manufacturing Co.	St. Louis, Mo.	AO	E. F. Johnson Co.	Waseca, Minn.
F	Carborundum Co.	Niagara Falls, N. Y.	AP	Lenz Electric Mfg. Co.	Chicago 47, Ill.
G	Centralab	Milwaukee 1, Wis.	AQ	Micro-Switch	Freeport, Ill.
H	Cinch-Jones Mfg. Co.	Chicago 24, Ill.	AR	Mechanical Industries Prod. Co.	Akron 8, Ohio
HP	Hewlett-Packard Co.	Palo Alto, Calif.	AS	Model Eng. & Mfg., Inc.	Huntington, Ind.
I	Clarostat Mfg. Co.	Dover, N. H.	AT	The Muter Co.	Chicago 5, Ill.
J	Cornell Dubilier Elec. Co.	South Plainfield, N. J.	AU	Ohmite Mfg. Co.	Skokie, Ill.
K	Hi-Q Division of Aerovox	Olean, N. Y.	AV	Resistance Products Co.	Harrisburg, Pa.
L	Erie Resistor Corp.	Erie 6, Pa.	AW	Radio Condenser Co.	Camden 3, N. J.
M	Fed. Telephone & Radio Corp.	Clifton, N. J.	AX	Shallcross Manufacturing Co.	Collingdale, Pa.
N	General Electric Co.	Schenectady 5, N. Y.	AY	Solar Manufacturing Co.	Los Angeles 58, Calif.
O	General Electric Supply Corp.	San Francisco, Calif.	AZ	Sealectro Corp.	New Rochelle, N. Y.
P	Girard-Hopkins	Oakland, Calif.	BA	Spencer Thermostat	Attleboro, Mass.
Q	Industrial Products Co.	Danbury, Conn.	BC	Stevens Manufacturing Co.	Mansfield, Ohio
R	International Resistance Co.	Philadelphia 8, Pa.	BD	Torrington Manufacturing Co.	Van Nuys, Calif.
S	Lectrohm Inc.	Chicago 20, Ill.	BE	Vector Electronic Co.	Los Angeles 65, Calif.
T	Littlefuse Inc.	Des Plaines, Ill.	BF	Weston Electrical Inst. Corp.	Newark 5, N. J.
U	Maguire Industries Inc.	Greenwich, Conn.	BG	Advance Electric & Relay Co.	Burbank, Calif.
V	Micamold Radio Corp.	Brooklyn 37, N. Y.	BH	E. I. DuPont	San Francisco, Calif.
W	Oak Manufacturing Co.	Chicago 10, Ill.	BI	Electronics Tube Corp.	Philadelphia 18, Pa.
X	P. R. Mallory Co., Inc.	Indianapolis, Ind.	BJ	Aircraft Radio Corp.	Boonton, N. J.
Y	Radio Corp. of America	Harrison, N. J.	BK	Allied Control Co., Inc.	New York 21, N. Y.
Z	Sangamo Electric Co.	Marion, Ill.	BL	Augat Brothers, Inc.	Attleboro, Mass.
AA	Sarkes Tarzian	Bloomington, Ind.	BM	Carter Radio Division	Chicago, Ill.
BB	Signal Indicator Co.	Brooklyn 37, N. Y.	BN	CBS Hytron Radio & Electric	Danvers, Mass.
CC	Sprague Electric Co.	North Adams, Mass.	BO	Chicago Telephone Supply	Elkhart, Ind.
DD	Stackpole Carbon Co.	St. Marys, Pa.	BP	Henry L. Crowley Co., Inc.	West Orange, N. J.
EE	Sylvania Electric Products Co.	Warren, Pa.	BQ	Curtiss-Wright Corp.	Carlstadt, N. J.
FF	Western Electric Co.	New York 5, N. Y.	BR	Allen B. DuMont Labs	Clifton, N. J.
GG	Wilkor Products, Inc.	Cleveland, Ohio	BS	Excel Transformer Co.	Oakland, Calif.
HH	Amphenol	Chicago 50, Ill.	BT	General Radio Co.	Cambridge 39, Mass.
II	Dial Light Co. of America	Brooklyn 37, N. Y.	BU	Hughes Aircraft Co.	Culver City, Calif.
JJ	Leecraft Manufacturing Co.	New York, N. Y.	BV	International Rectifier Corp.	El Segundo, Calif.
KK	Switchcraft, Inc.	Chicago 22, Ill.	BW	James Knights Co.	Sandwich, Ill.
LL	Gremar Manufacturing Co.	Wakefield, Mass.	BX	Mueller Electric Co.	Cleveland, Ohio
MM	Carad Corp.	Redwood City, Calif.	BY	Precision Thermometer & Inst. Co.	Philadelphia 30, Pa.
NN	Electra Manufacturing Co.	Kansas City, Mo.	BZ	Radio Essentials Inc.	Mt. Vernon, N. Y.
OO	Acro Manufacturing Co.	Columbus 16, Ohio	CA	Raytheon Manufacturing Co.	Newton, Mass.
PP	Alliance Manufacturing Co.	Alliance, Ohio	CB	Tung-Sol Lamp Works, Inc.	Newark 4, N. J.
QQ	Arco Electronics, Inc.	New York 13, N. Y.	CD	Varian Associates	Palo Alto, Calif.
RR	Astron Corp.	East Newark, N. J.	CE	Victory Engineering Corp.	Union, N. J.
SS	Axel Brothers Inc.	Long Island City, N. Y.	CF	Weckesser Co.	Chicago 30, Ill.
TT	Belden Manufacturing Co.	Chicago 44, Ill.	CG	Wilco Corporation	Indianapolis, Ind.
UU	Bird Electronics Corp.	Cleveland 14, Ohio	CH	Winchester Electronics, Inc.	Santa Monica, Calif.
VV	Barber Colman Co.	Rockford, Ill.	CI	Malco Tool & Die	Los Angeles 42, Calif.
WW	Bud Radio Inc.	Cleveland 3, Ohio	CJ	Oxford Electric Corp.	Chicago 15, Ill.
XX	Allen D. Cardwell Mfg. Co.	Plainville, Conn.	CK	Camloc-Fastener Corp.	Paramus, N. J.
YY	Cinema Engineering Co.	Burbank, Calif.	CL	George K. Garrett	Philadelphia 34, Pa.
ZZ	Any brand tube meeting RETMA standards.		CM	Union Switch & Signal	Swissvale, Pa.
AB	Corning Glass Works	Corning, N. Y.	CN	Radio Receptor	New York 11, N. Y.
AC	Dale Products, Inc.	Columbus, Neb.	CO	Automatic & Precision Mfg. Co.	Yonkers, N. Y.
AD	The Drake Mfg. Co.	Chicago 22, Ill.	CP	Bassick Co.	Bridgeport 2, Conn.
AE	Elco Corp.	Philadelphia 24, Pa.	CQ	Birnbach Radio Co.	New York 13, N. Y.
AF	Hugh H. Eby Co.	Philadelphia 44, Pa.	CR	Fischer Specialties	Cincinnati 6, Ohio
AG	Thomas A. Edison, Inc.	West Orange, N. J.	CS	Telefunken (c/o MYM, Inc.)	New York, N. Y.
AH	Fansteel Metallurgical Corp.	North Chicago, Ill.	CT	Potter-Brumfield Co.	Princeton, Ind.
AI	General Ceramics & Steatite Corp.	Keasbey, N. J.	CU	Cannon Electric Co.	Los Angeles, Calif.
AJ	The Gudeman Co.	Sunnyvale, Calif.	CV	Dynac, Inc.	Palo Alto, Calif.
			CW	Good-All Electric Mfg. Co.	Ogallala, Nebr.

CLAIM FOR DAMAGE IN SHIPMENT

The instrument should be tested as soon as it is received. If it fails to operate properly, or is damaged in any way, a claim should be filed with the carrier. A full report of the damage should be obtained by the claim agent, and this report should be forwarded to us. We will then advise you of the disposition to be made of the equipment and arrange for repair or replacement. Include model number and serial number when referring to this instrument for any reason.

WARRANTY

Hewlett-Packard Company warrants each instrument manufactured by them to be free from defects in material and workmanship. Our liability under this warranty is limited to servicing or adjusting any instrument returned to the factory for that purpose and to replace any defective parts thereof. Klystron tubes as well as other electron tubes, fuses and batteries are specifically excluded from any liability. This warranty is effective for one year after delivery to the original purchaser when the instrument is returned, transportation charges prepaid by the original purchaser, and when upon our examination it is disclosed to our satisfaction to be defective. If the fault has been caused by misuse or abnormal conditions of operation, repairs will be billed at cost. In this case, an estimate will be submitted before the work is started.

If any fault develops, the following steps should be taken:

1. Notify us, giving full details of the difficulty, and include the model number and serial number. On receipt of this information, we will give you service data or shipping instructions.
2. On receipt of shipping instructions, forward the instrument prepaid, to the factory or to the authorized repair station indicated on the instructions. If requested, an estimate of the charges will be made before the work begins provided the instrument is not covered by the warranty.

SHIPPING

All shipments of Hewlett-Packard instruments should be made via Truck or Railway Express. The instruments should be packed in a strong exterior container and surrounded by two or three inches of excelsior or similar shock-absorbing material.

DO NOT HESITATE TO CALL ON US

HEWLETT-PACKARD COMPANY

Laboratory Instruments / for Speed and Accuracy

1501 Page Mill Road

CABLE



Palo Alto, California

"HEWPACK"